



PURELITE SLIM

PURELITE SLIM is something to admire before it has even been turned on. The slimmest and thinnest luminaire in the industry, it is a feat of imagination and innovation. But then a switch is flicked. And PURELITE SLIM becomes a sleek strip of pure, uninterrupted, exceptional light. Although its design is hard to comprehend, the luminaire itself is easy to install at every stage of a project. So, the possibilities are as wide as PURELITE SLIM is so elegantly thin.

FEATURES

- Shadow-free lines of light, incl. illumination of the ceiling, timeless design
- Simple to integrate into the architecture thanks to its ultra-flat design: height of only 35 mm incl. control gear
- Available with integrated RUN diffuser (PURELITE SLIM D) or office-compatible RUN+ diffuser (PURELITE SLIM)
- Omnidirectional, with illumination of the ceiling, also available with direct lighting
- Batten luminaire range with a 2.5 cm design from standard, enables wall-to-wall planning

TECHNICAL DATA

Luminous flux of luminaire	1600-3100 lm, Office 2150 lm
Colour temperature	3000 K, 4000 K
Colour Rendering Index (CRI)	≥ 80
Maintained luminous flux	L80 75'000 h
Glare value	Up to UGR < 19 $L_{max} \geq 65^\circ \leq 3000 \text{ cd/m}^2$
Protection class	I
Ingress Protection	IP20
Photobiological safety	risk group 0, no risk

SPECIFICATIONS

- Recessed ceiling, ceiling and wall mounting, pendant luminaire and channel lighting system
- Extremely good homogeneous direct illumination and all-round illumination
- support profiles made of natural anodised aluminium
- Clip-in LED batten with integrated through-wiring for quick and easy mounting
- LED batten luminaire replaceable on site
- High luminous efficacy of up to 150 lm/W

APPLICATION AREAS

Office & Education: open-plan offices, individual offices, classrooms, meeting rooms, foyers and lobbies, circulation zones

Retail & Hospitality: hotels, restaurants

Home & Living

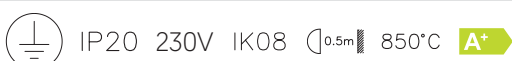

OVERVIEW OF PURELITE SLIM SYSTEM

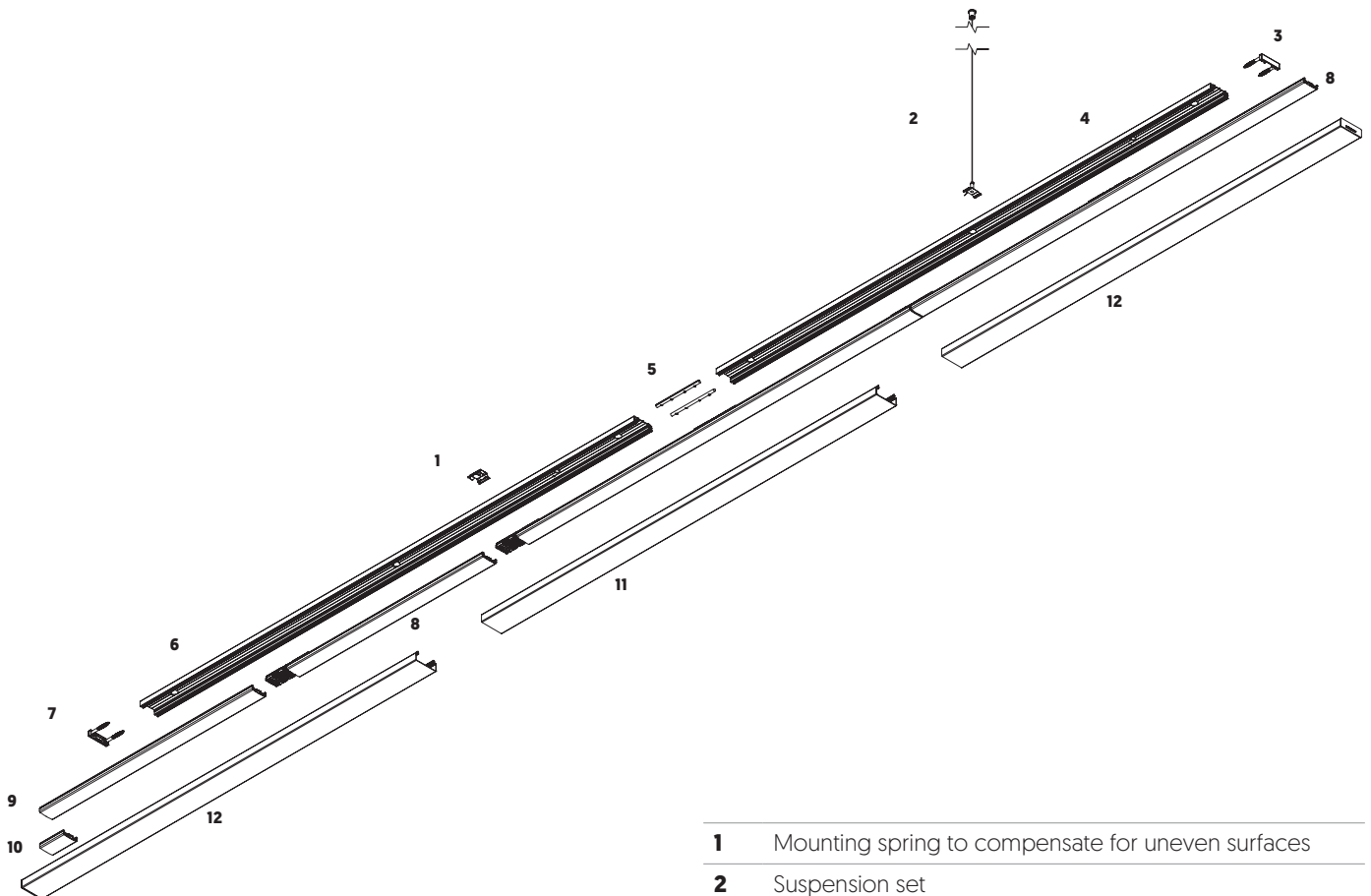

1	Mounting spring to compensate for uneven surfaces
2	Suspension set
3	End faces
4	Support profile for channel lighting system
5	Profile connector set
6	Support profile for channel lighting system
7	End faces
8	System batten Master
9	System batten Slave End 650 mm
10	System batten Slave End 75 mm
11	Intermediate diffuser, opal or office-compatible [RUN+]
12	Diffuser Initial/end, opal or office-compatible [RUN+], with ceiling trim

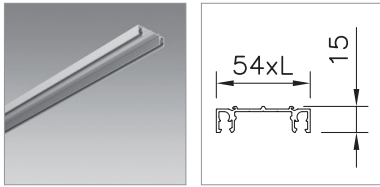

PROFILO DI SUPPORTO PER SISTEMI LINEARI PURELITE SLIM
WITHOUT CEILING TRIM

required length: 3 mm longer than the batten, please bear in mind the mounting direction, natural-colour anodised

Length	Ref. n°
2403 mm	2004.4778
3603 mm	2004.4779
4803 mm	2004.4780

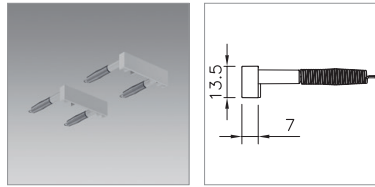

STIRNSEITE PURELITE SLIM
WITHOUT CEILING TRIM

for support profile, 2 pieces, thickness 7 mm, synthetic material metallic silver, no visible screws

Notes	Ref. n°
	2004.4076



INFEED KIT PURELITE SLIM

Including splint washer and tool for removing the batten and the diffuser from the support profile

Notes	Ref. n°
	2004.4081

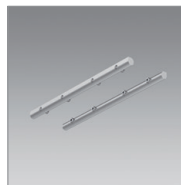

PROFILE CONNECTOR SET PURELITE SLIM

for all Purelite support profiles

Notes	Ref. n°
	2004.6466

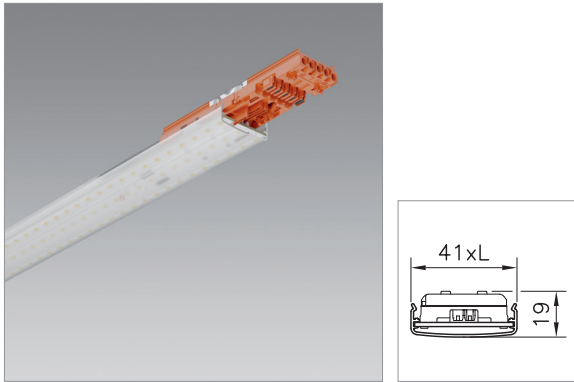

BATTEN LUMINAIRE PURELITE SLIM D
BATTEN LUMINAIRE MASTER

Master with control gear, 1 pc required per line of light, mount at the start of the line, incl. pre-installed connector to the next module, can be extended with a master or once with a slave.

Batten luminaires of the same type provide the same impression of brightness regardless of their length. Therefore, only batten luminaires of the same type should be applied together in one system, i.e. only xHE or only HE or only HPE.

Luminous flux of luminare PURELITE SLIM per 1,2 m for xHE 2000 lm, for HE 2350 lm and for HPE 3100 (each at 4000K).

Luminous flux of luminare PURELITE SLIM OFFICE per 1,2 m for xHE 1840 lm, for HE 2150 lm and for HPE 2750 (each at 4000K).

System power	Length	Notes	Colour temperature	Light control	Ref. n°
9 W	600 mm	xHE	3000 K	DALI	2004.5183
10 W	600 mm	HE	3000 K	DALI	2004.5187
12 W	600 mm	HPE	3000 K	DALI	2005.2382
15 W	1200 mm	xHE	3000 K	DALI	2004.5184
17 W	1200 mm	HE	3000 K	DALI	2004.5188
21 W	1200 mm	HPE	3000 K	DALI	2005.2383
18 W	1500 mm	xHE	3000 K	DALI	2004.5185
21 W	1500 mm	HE	3000 K	DALI	2004.5189
26 W	1500 mm	HPE	3000 K	DALI	2005.2384
27 W	2400 mm	xHE	3000 K	DALI	2004.5186
31 W	2400 mm	HE	3000 K	DALI	2004.5190
39 W	2400 mm	HPE	3000 K	DALI	2005.2385
9 W	600 mm	xHE	4000 K	DALI	2004.5215
10 W	600 mm	HE	4000 K	DALI	2004.5219
12 W	600 mm	HPE	4000 K	DALI	2005.2386
15 W	1200 mm	xHE	4000 K	DALI	2004.5216
17 W	1200 mm	HE	4000 K	DALI	2004.5220
21 W	1200 mm	HPE	4000 K	DALI	2005.2387
18 W	1500 mm	xHE	4000 K	DALI	2004.5217
21 W	1500 mm	HE	4000 K	DALI	2004.5221
26 W	1500 mm	HPE	4000 K	DALI	2005.2388
27 W	2400 mm	xHE	4000 K	DALI	2004.5218
31 W	2400 mm	HE	4000 K	DALI	2004.5222
39 W	2400 mm	HPE	4000 K	DALI	2005.2389

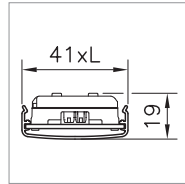

BATTEN LUMINAIRE PURELITE SLIM D
BATTEN LUMINAIRE SLAVE

End module Slave without control gear, only 1 piece per line required, installation at the end of the line, use after a Master module
System power and luminous flux dependent on the respective master module

Length	Notes	Colour temperature	Light control	Ref. n°
75 mm	xHE / HE / HPE	3000 K	DALI	2004.5214
100 mm	xHE / HE / HPE	3000 K	DALI	2004.5213
125 mm	xHE / HE / HPE	3000 K	DALI	2004.5212
150 mm	xHE / HE / HPE	3000 K	DALI	2004.5211
175 mm	xHE / HE / HPE	3000 K	DALI	2004.5210
200 mm	xHE / HE / HPE	3000 K	DALI	2004.5209
225 mm	xHE / HE / HPE	3000 K	DALI	2004.5208
250 mm	xHE / HE / HPE	3000 K	DALI	2004.5207
275 mm	xHE / HE / HPE	3000 K	DALI	2004.5206
300 mm	xHE / HE / HPE	3000 K	DALI	2004.5205
325 mm	xHE / HE / HPE	3000 K	DALI	2004.5204
350 mm	xHE / HE / HPE	3000 K	DALI	2004.5203
375 mm	xHE / HE / HPE	3000 K	DALI	2004.5202
400 mm	xHE / HE / HPE	3000 K	DALI	2004.5201
425 mm	xHE / HE / HPE	3000 K	DALI	2004.5200
450 mm	xHE / HE / HPE	3000 K	DALI	2004.5199
475 mm	xHE / HE / HPE	3000 K	DALI	2004.5198
500 mm	xHE / HE / HPE	3000 K	DALI	2004.5197
525 mm	xHE / HE / HPE	3000 K	DALI	2004.5196
550 mm	xHE / HE / HPE	3000 K	DALI	2004.5195
575 mm	xHE / HE / HPE	3000 K	DALI	2004.5194
600 mm	xHE / HE / HPE	3000 K	DALI	2004.5193
625 mm	xHE / HE / HPE	3000 K	DALI	2004.5192
650 mm	xHE / HE / HPE	3000 K	DALI	2004.5191
75 mm	xHE / HE / HPE	4000 K	DALI	2004.5246
100 mm	xHE / HE / HPE	4000 K	DALI	2004.5245
125 mm	xHE / HE / HPE	4000 K	DALI	2004.5244
150 mm	xHE / HE / HPE	4000 K	DALI	2004.5243
175 mm	xHE / HE / HPE	4000 K	DALI	2004.5242
200 mm	xHE / HE / HPE	4000 K	DALI	2004.5241
225 mm	xHE / HE / HPE	4000 K	DALI	2004.5240
250 mm	xHE / HE / HPE	4000 K	DALI	2004.5239
275 mm	xHE / HE / HPE	4000 K	DALI	2004.5238
300 mm	xHE / HE / HPE	4000 K	DALI	2004.5237
325 mm	xHE / HE / HPE	4000 K	DALI	2004.5236
350 mm	xHE / HE / HPE	4000 K	DALI	2004.5235
375 mm	xHE / HE / HPE	4000 K	DALI	2004.5234

400 mm	xHE / HE / HPE	4000 K	DALI	2004.5233
425 mm	xHE / HE / HPE	4000 K	DALI	2004.5232
450 mm	xHE / HE / HPE	4000 K	DALI	2004.5231
475 mm	xHE / HE / HPE	4000 K	DALI	2004.5230
500 mm	xHE / HE / HPE	4000 K	DALI	2004.5229
525 mm	xHE / HE / HPE	4000 K	DALI	2004.5228
550 mm	xHE / HE / HPE	4000 K	DALI	2004.5227
575 mm	xHE / HE / HPE	4000 K	DALI	2004.5226
600 mm	xHE / HE / HPE	4000 K	DALI	2004.5225
625 mm	xHE / HE / HPE	4000 K	DALI	2004.5224
650 mm	xHE / HE / HPE	4000 K	DALI	2004.5223

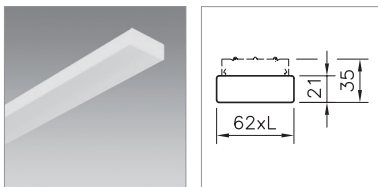

DIFFUSER PURELITE SLIM OFFICE
FOR SURFACE MOUNTING

Optics, suitable for application in offices, UGR <= 19, clear, PMMA,
2 diffusers, each with 1 front side, required per line of light

Notes	Lenght	Ref. n°
with 1 end face	2415 mm	2005.1107
with 1 end face	4812 mm	2005.1108
without end face	2400 mm	2005.1110
without end face	4798 mm	2005.1111

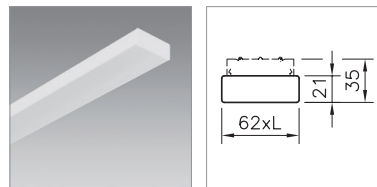

DIFFUSER PURELITE SLIM OFFICE
FOR SURFACE MOUNTING

Optics, suitable for application in offices, UGR <= 19, clear, PMMA,
One-piece diffuser with two end faces

Lenght	Ref. n°
2431 mm	2005.1065
3631 mm	2005.1091
4831 mm	2005.1099

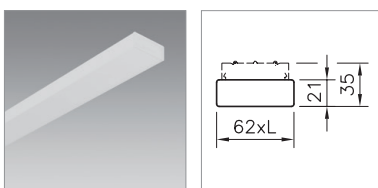

DIFFUSER PURELITE SLIM
FOR SURFACE MOUNTING

2 diffusers, each with 1 front side, required per line of light, opal, PMMA

Notes	Lenght	Ref. n°
with 1 end face	2414 mm	2004.7503
with 1 end face	4812 mm	2004.7506
without end face	2400 mm	2004.7513
without end face	4798 mm	2004.7514

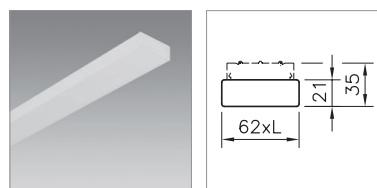

DIFFUSER PURELITE SLIM
FOR SURFACE MOUNTING

One-piece diffuser with two end faces, opal, PMMA

Lenght	Ref. n°
2431 mm	2004.4796
3631 mm	2004.4798
4831 mm	2004.4799

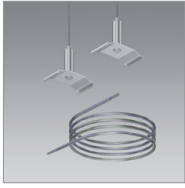

SUSPENSION SET PURELITE SLIM D

Length 1500 mm, with wire suspension and self-lock, load max. 20 kg, mounting recommendation: every 1.5 m

Notes	Ref. n°
2 wire cords, can be clipped into place, with 2 m power feed cable, transparent, with cable clamp	2004.4908
1 wire cord, can be clipped into place, adjustable	2004.4079

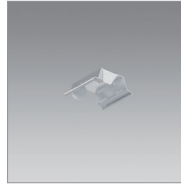

MOUNTING SPRING KIT PURELITE SLIM D

made of spring steel, to facilitate mounting the support profile on the ceiling, to compensate for uneven surfaces, as a placeholder for cable routing, Recommended: all 1.5 m

Notes	Ref. n°
1 piece	2004.1005