

narbutas



From one computer desk to Europe's fastest-growing furniture company

All of the energy we use to create our ergonomic and long-lasting products is sustainable: solar, wind, and water-powered.

GUARANTEE

5 year for the standard furniture, chairs and TWIST&SIT lounge seating system

3 year for the lounge seating and electric parts of the desk system ONE

2 year for the electrical accessories, acoustic desk screens ROUND PET and electric parts of the desk system B-ACTIVE

Our story began in 1991. We set out on a mission to make quality and modern workspaces available to more people.

From a single product – a desk for a computer in 1991, our range grew to offer everything you need to furnish a modern office.

We produce diverse products from desks and chairs to acoustic furniture rich in technological solutions.

All of this is done in Lithuania, home to one of the largest office furniture factories in Eastern and Central Europe.

Apart from the constantly expanding production capabilities and technologies, over time our company has developed strong in-house innovation, custom-made furniture, IT, logistics, customer support departments.

All of this allows us to ensure the quality of every single step in product development.

ABOUT US	> 5
DESIGNERS	> 8
DESKS & TABLES	> 12
STORAGE	> 100
ACOUSTIC SOLUTIONS	> 132
CHAIRS	> 176
LOUNGE & SOFT FURNITURE	> 262
EXECUTIVE FURNITURE	> 306
RECEPTION FURNITURE	> 332
CUSTOM-MADE PRODUCTS	> 350
MATERIALS	> 360
DEFINITION OF ICONS	> 366

FROM CONCEPT TO FULL EXECUTION

“*I also found out that, just like me, our customers like functional and good quality products and are not willing to pay for what they do not need. That is why we design and manufacture functional, high-quality, attractive yet simple things. Our design motto is: Nothing unnecessary.*”

Petras Narbutas,
company founder and owner

Concept & Design

In-house design team

Our award-winning in-house design team comprises professionals with almost 30 years of experience in furniture production and design. The achievements of the team were most recently celebrated by the prestigious Red Dot Award for Product Design 2019.

Working with international designers

6 NARBUTAS experienced product development team and innovation group work closely together to find optimal, high-quality solutions. Additionally, we collaborate with internationally known designers from Lithuania, Italy, Denmark, Japan, etc. Long-term work with international partners brings great results.

Find more about our work with designers on pages 8-11.

Globally relevant

By combining Italian design, subtle Scandinavian minimalism, and natural Lithuanian coziness, we deliver design that will outlast short-lived regional fads and will be easy to integrate, expand, or combine with existing furniture and interior solutions.

Nothing unnecessary

It matters to us that our furniture is functional, high-quality, and attractively designed, and at the same time, we make sure that our customers do not have to pay for what they do not need.

Manufacturing

The continuous modernization and automation of NARBUTAS furniture factory in Lithuania ensure a reliable production process and the highest quality of furniture produced, both standard and custom-made.

Using advanced technology

We make substantial investments in machinery and automate processes for our people to be able to focus on what really matters. Our main goal is to reduce the workload for our employees and to increase our production volume.

Integrating lean production

We follow the lean method to be able to hedge against the risk of error even during the rapid growth of volumes. We are growing at an incredible speed: around 40% a year. The lean method has allowed us to be flexible and to eliminate all possible errors in advance. Even with this growth, we are continuing to manufacture within the 2-week window that has always been our standard.

Assuring quality

Our quality control is executed in multiple stages to assure there are no errors in the final result. First, we check the quality of materials received from our suppliers, secondly, the components produced, finally, one more inspection of the completed components is conducted before the packaging process. While all these processes take a long time, they enable us to ensure that only high-quality products are delivered to our customers.

Set-up & Consulting

We offer various solutions aimed at making the whole process, from choosing your furniture to setting it up as quick and simple as possible.

Extensive customer support

Highly qualified NARBUTAS customer support team speaks seven languages (Lithuanian, English, French, German, Russian, Italian, Polish). Dedicated key account managers assure timely response and work with tight client feedback loops.

Tailored visualizations

Our team will help you make the most of your office space by suggesting a layout for your office and the furniture according to your expressed needs. We make it easier for you to imagine products in your space by creating tailored 3D visualizations.

Online ordering system and additional services

NARBUTAS online price list contains extensive information regarding our product ranges and services including catalogues, product presentations, technical sheets, operation manuals, and pictures. All of our assembling schemes are made available on our website or can be found by scanning the QR code on the box of the product. This way we make it easier for clients to plan the assembling process and time in advance. We provide videos explaining the more difficult parts of assembling. For your convenience also provide full support in logistical arrangements.

Custom-made solutions

There is no office culture that works in the same way, there is no team that has the same needs. This is why we specialize in custom-made office furniture that attends to individual needs.

Flexibility & professionalism

Experienced team of professionals can adapt the size or materials of our current standard products to suit your office requirements or create new ones. Engineers of Non-standard Furniture Department will consider every last detail to suggest the best solution and bring your vision to life. All ideas turn into functional and ergonomic office furniture.

Technical capacity

Our state-of-the-art equipment is highly universal and allowing us to manufacture both large and small individual orders. It makes us very flexible when it comes to customer requests and the capability of realizing even the most complex projects. We have mastered the use of diverse materials, creating furniture with bentwood or metal elements of varying complexity, as well as upholstered and acoustic furniture.

Find more about the custom-made solutions we offer our customers on pages 350-359.

DESIGNERS

Baldanzi & Novelli Designers



“The extraordinary thing I have discovered in Lithuania is the desire to create things. While working together hand in hand our two cultures mix and complement each other resulting in a third element – an energy that cannot be found elsewhere.”

Baldanzi & Novelli's collaboration with Narbutas began in 2013 with mutual interest. Narbutas were interested in Baldanzi & Novelli's more than 30 years of experience, great design culture, originality, and familiarity with cutting-edge technology, while the designers were attracted to the company's clear-cut vision and recognizable style.

DESIGNERS

Christina Strand and Niels Hvass

“We met the NARBUTAS team and felt that the company's strategy fitted into our way of working. We developed a good relationship and met great enthusiastic people who want to move the company forward.”



Strand + Hvass have many years of experience in the world of design. Over the years, their style has developed to become modern and innovative, yet based on classic values and a timeless aesthetic. They have a bold vision of the value and impact of design on today's world and create unique products to match.

8

WIND

TASK CHAIRS

> 186

HIGH SWIVEL CHAIRS

> 214

VISITOR CHAIRS

> 228



NORTH CAPE

TASK CHAIRS

> 194

EXECUTIVE CHAIRS

> 218

VISITOR CHAIRS

> 236



ARCIPELAGO

LOUNGE & SOFT FURNITURE

> 288



ARCIPELAGO Wood

ACOUSTIC FURNITURE

> 170



BALDANZI & NOVELLI DESIGNERS

9

TWIST&SIT Soft

LOUNGE & SOFT FURNITURE

> 266



LOUNGE & SOFT FURNITURE

> 270



TWIST&SIT

LOUNGE & SOFT FURNITURE

> 274



LOUNGE & SOFT FURNITURE

> 278



VISITOR CHAIRS

> 232



HIGH CHAIRS

> 256



JAZZ

MEETING TABLES

> 82

HIGH TABLES

> 92



JAZZ Silent Box

ACOUSTIC FURNITURE

> 160



JAZZ Chill Out

LOUNGE & SOFT FURNITURE

> 294



SOFT ROCK

LOUNGE & SOFT FURNITURE

> 282



CHRISTINA STRAND AND NIELS HVASS

Gediminas Juška



“ I associate Narbutas with professionalism, solidity, and consistency. The company's products stand for high quality and a modern, elegant design. ”

Gediminas Juška began working with Narbutas in 2000, soon after completing his architecture degree at the Vilnius Academy of Arts. Since then his creations for the company have won the Grand Prix at the Furniture 2001 Fair, the Main Prize of Good Design 2012, and other prizes at national and international events. Juška has always specialized in office furniture and interiors, and his achievements have earned him recognition in Lithuania and beyond.

MOVE&LEAD

EXECUTIVE FURNITURE

> 308



AIR

DESKS	MEETING & CONFERENCE TABLES	EXECUTIVE FURNITURE
> 62	> 80	> 326



Roberto Lucci and Paolo Pampanoni



Roberto Lucci has been designing for over half a century, always driven by the notion that design is creative problem-solving. Or, as he puts it:

“ Creativity alone is not design and problem solving without creativity is not design either.”

His partner Paolo Pampanoni is an Umbria-based architect specializing in architecture for work and design. His leading principle is the “performance principle”: every aspect of the design of space or products must lead to a formal, functional, technical or economic performance.

PLANA

MEETING & CONFERENCE TABLES	EXECUTIVE FURNITURE
> 74	> 322



Kazuko Okamoto

“ I find it interesting to create furniture that proposes ways to use it, to live, and to make a place without being restricted by a pre-existing concept.”



CUMULUS

LOUNGE & SOFT FURNITURE

> 299



Born in Chiba, Japan, Kazuko Okamoto spent ten years after her graduation from Tokyo's ICS College of Arts working in Japan before moving to Milan and working for a studio, then as a freelance designer. Her unique point of view earned her second place at the “Only for Women 2001 Awards” at Milan's Salone del Mobile. functional, technical or economic performance.

DESKS & TABLES

SIT-STAND DESKS



B-ACTIVE
> 18



ONE
> 36

12



ACTIVE
> 22



MOTION
> 26



EASY
> 32

DESKS



ROUND
> 38



T-EASY
> 66



NOVA Wood
> 48



ONE H
> 67



NOVA
> 54



OPTIMA C
> 68



AIR
> 62



OPTIMA Plus
> 69

13

CONFERENCE & MEETING TABLES



NOVA Wood
> 70



JAZZ
> 82



FORUM
> 86



PLANA
> 74



FLIP-TOP
> 84



OPTIMA
> 87

14



NOVA
> 78



FLIP-TOP.II
> 84



T-EASY
> 87



AIR
> 80



FOLDING
> 84

CONFERENCE WALLS



MEDIA
> 88

15

HIGH TABLES



NOVA Wood
> 90



NOVA
> 92



LIGHT
> 92



JAZZ
> 92

16

OCCASIONAL TABLES



NOVA Wood
> 94



NOVA
> 98



MOBI
> 96



NOVUS
> 98



AMBER
> 97



FORUM
> 99



SITO
> 97



OPTIMA
> 99

17

B-ACTIVE

Enjoy more freedom,
physical activity and
productivity!

B-ACTIVE is a practical electric height-adjustable
desk that stands for ergonomics and quality,
which is now even more accessible to customers.



↑
MAX
1175 mm
MIN
705 mm
↓

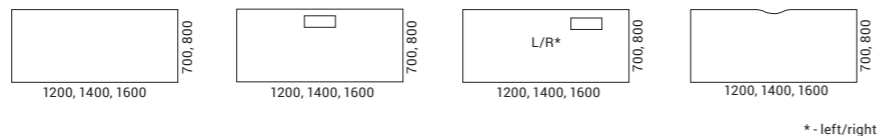

* - left/right



Every detail matters

You can choose from two different types of metal legs.
Create your own custom B-ACTIVE desk by choosing
desired components from the desktop right down to
the feet.



Safety and stability

For greater safety at the workplace, B-ACTIVE has
an integrated anti-collision feature and a feature
protecting the desk against overloading.

BERTA
AD7

20

SYNERGY
S62

21



ACTIVE

An easy way to stay
active at work!

ACTIVE desking system can be best described
in two words: functionality and quality.



22

↑
MAX
1200 / 1300 mm

MIN
650 / 725 mm
↓

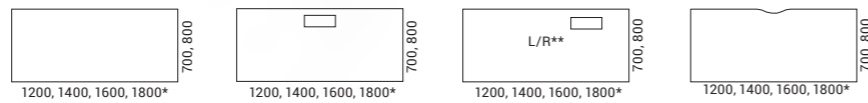

* - only 800
** - left/right



Easy to customize

The desk height can be adjusted by pressing
a selected button: a memory position button
with a display, or up and down controls.



23

Feet design

Choose from three types of metal feet.
All the designs look minimalist, light
and with different elegant accents.



24

ACTIVE

Anti-collision feature

Both the 2-level and 3-level feet sensor will automatically stop the desk's movement if it senses an obstacle in its path. The anti-collision feature reduces the likelihood of damage should the desk collide with a hard object.



25

ACTIVE

MOTION

Makes you move
forward!

The system is available as single desks
or bench desks designed for a flexible
arrangement of workstations as well
as for individual or group work.



26

↑
MAX
1200 / 1300 mm

MIN
650 / 700 mm
↓

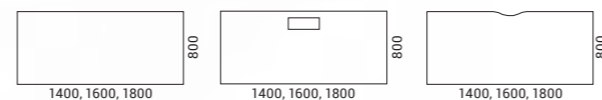



Acoustics and concentration

A fixed-height acoustic desk screen MODUS designed for bench desks will ensure acoustic comfort and help your employees maintain concentration. Furthermore, the double-sided acoustic desk screens allow you to create colourful combinations.



Leg design

MOTION desks offer a choice of two different leg designs. H-shaped metal legs provide a more generous space for movement and storage. Those who desire more privacy can choose a desk with panel legs which visually cover up the space under the desk and add an aesthetic look to it.

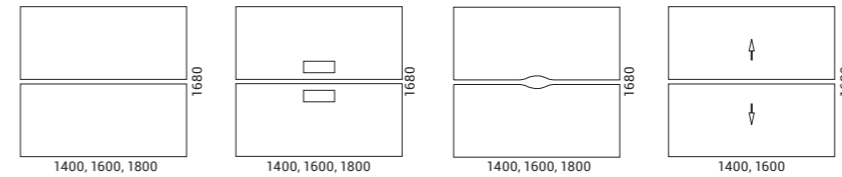

SIT-STAND
DESKS

30

31

MOTION

MOTION



Makes it easy to
be productive!

Easy to choose, easy to use, and easy to
stay productive for a longer period of time.

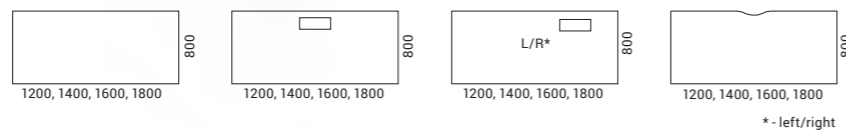

Stability

Two-desk benches are an excellent solution
for combining workstations. The shared leg
of the sit-stand desks provide maximum
stability of the joined desks.

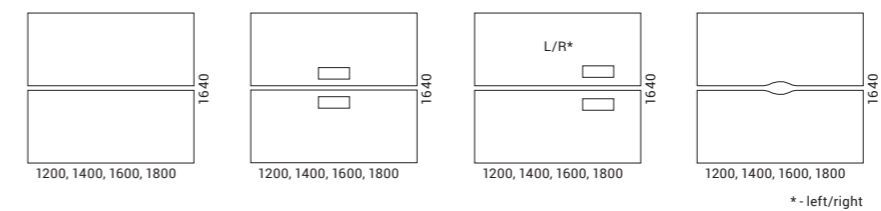

STEP Melange
L12

STEP Melange
L12

STEP Melange
L12



ONE

Ideal for any office

ONE sit-stand desks are ideal for any office space thanks to their design and great value for money that they offer.

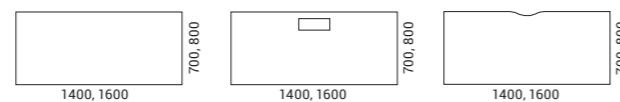

ROUND

For effective workplace design

Use the office space effectively with a ROUND system which combines office desks, cabinets and screens. Creating open and private workplaces for your team was never as easy.



38

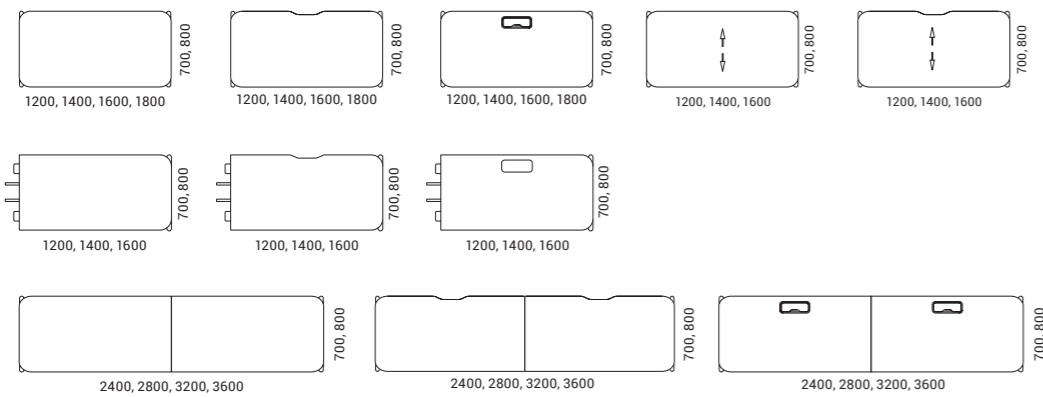

* Desktops are also available with square corners.



RUNNER mesh RM4

STEP L15

From single desk to bench desks for collaborative tasks

40



41

Create workplaces based on the number of employees and the nature of the tasks performed ranging from single desks to bench desks. The latter are very popular as they enable both small and large teams to create a workspace ideally suited for collaborative tasks.

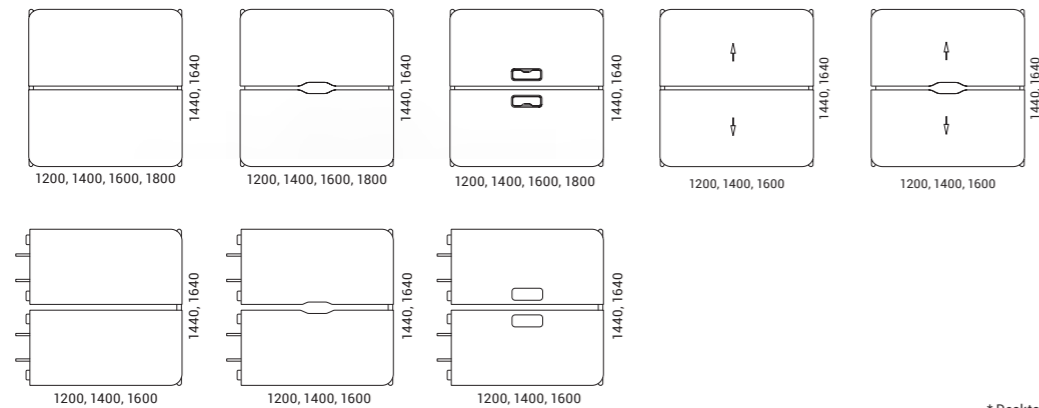

* Desktops are also available with square corners.

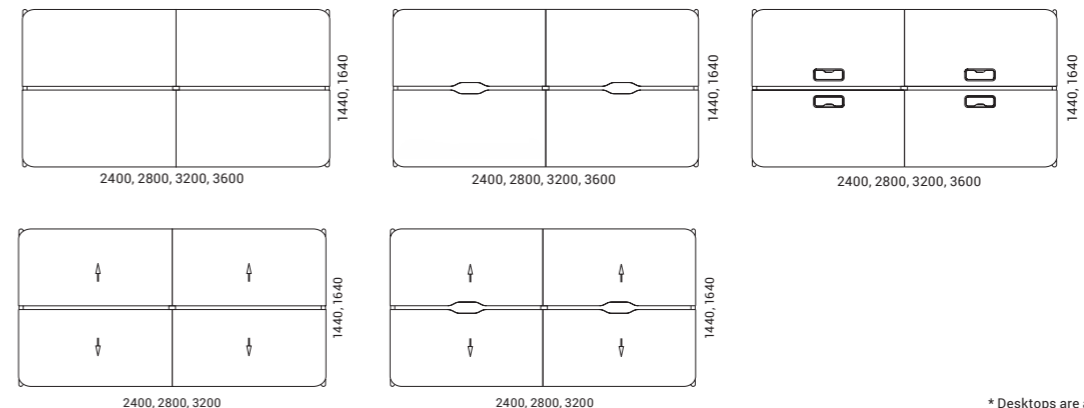

* Desktops are also available with square corners.

Modular cabinet system

Desk height cabinets can be made higher with additional shelving units and which can be single-sided or double-sided and open or closed.

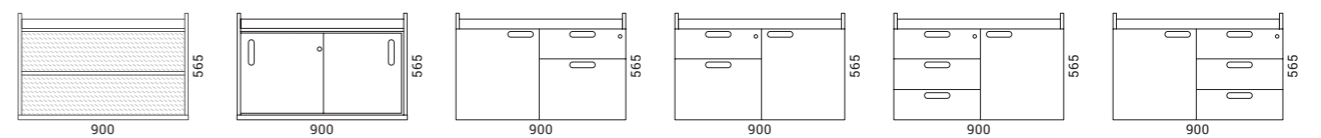
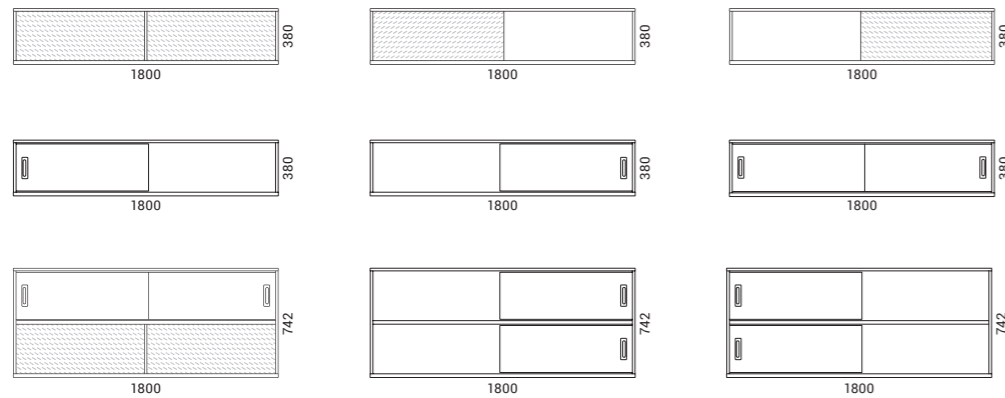

DESKS

Power management solutions with wide range of applications



44

The ROUND desk system allows for easy connection of several workplaces into a single electrical circuit. Cabinets serve an important function in power supply and data transmission as they come with a grommet for wire and cable management.

ROUND



ROUND

DESKS

DESKS



ROUND

ROUND

NOVA Wood

CONFERENCE &
MEETING TABLES

> 70

HIGH
TABLES

> 90

OCCASIONAL
TABLES

> 94

A touch of nature
in your office!

NOVA Wood is a desking system that adds
a delicate sense of luxury to your office
and brings you closer to nature and
home atmosphere!



48

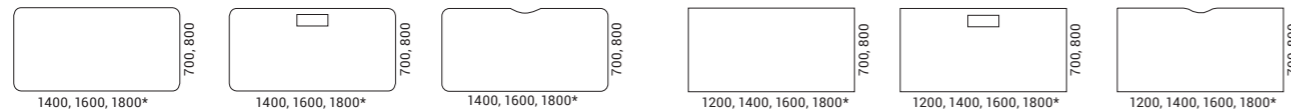

* - only 800

Every table is unique

Wood texture and wide growth rings create a distinctive pattern. Stained and lacquered wood reveals the pattern even more. Natural wood tends to change its colour over time.



You can adapt bench desks consisting of two desks to your office dynamics by using supplementary partitions which allow you to easily increase the number of workplaces.

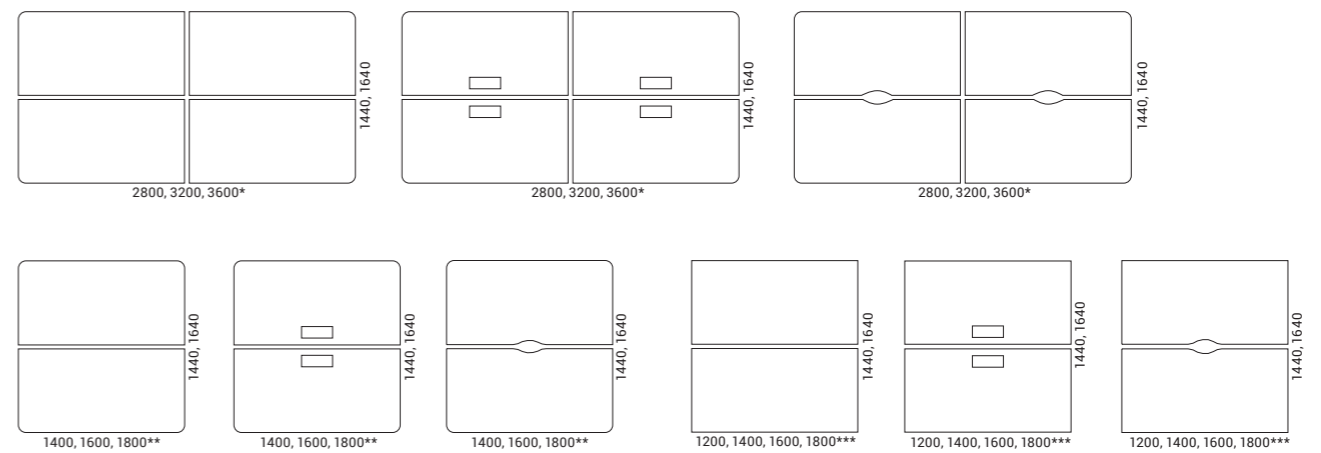

* - only 1640
 ** - only 800, 1640
 *** - only 800

DESKS

DESKS



ERA
C09

NOVA

CONFERENCE & MEETING TABLES

> 78

HIGH TABLES

> 92

OCCASIONAL TABLES

> 98

EXECUTIVE FURNITURE

> 330

Modern classic

Even the name itself derived from the Latin word meaning something "new". If you change the desktop texture or leg colour, you will be able to create a whole new desk.



U

Regular U-shaped legs is a universal design solution.



A

A-shaped legs are sure to add subtle look and elegance to NOVA A desks.



O

O-shape desk legs are unique in that you can additionally order a special divider designed for two-seat and four-seat desks.



H

Height adjustable feet allow you to easily change the desk height from 620 mm to 850 mm.



DESKS

You can adapt bench desks consisting of two desks to your office dynamics by using supplementary partitions which allow you to easily increase the number of workplace.

DESKS



56

57

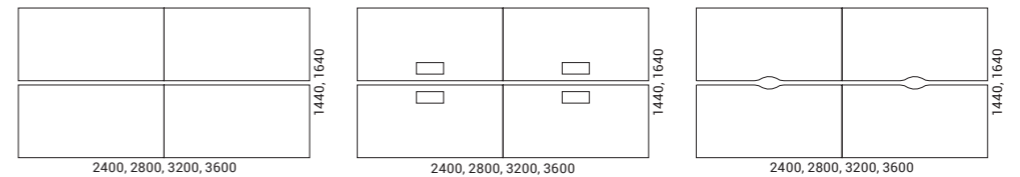
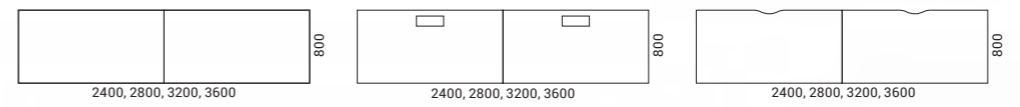
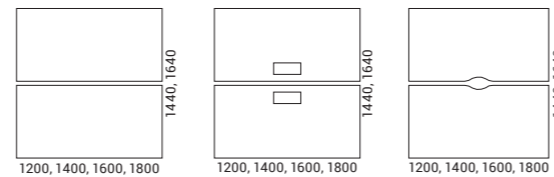
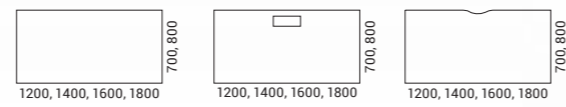

Sliding desktop

Choose functional NOVA U Slide desks with a push/pull desktop. The arrangement of the cable duct, the access to the power unit and cable management will be much more convenient. These desks are based on a very simple principle: to access the cable duct, pull the desktop toward yourself; if you want to conceal the cables, then simply push the desktop slightly.

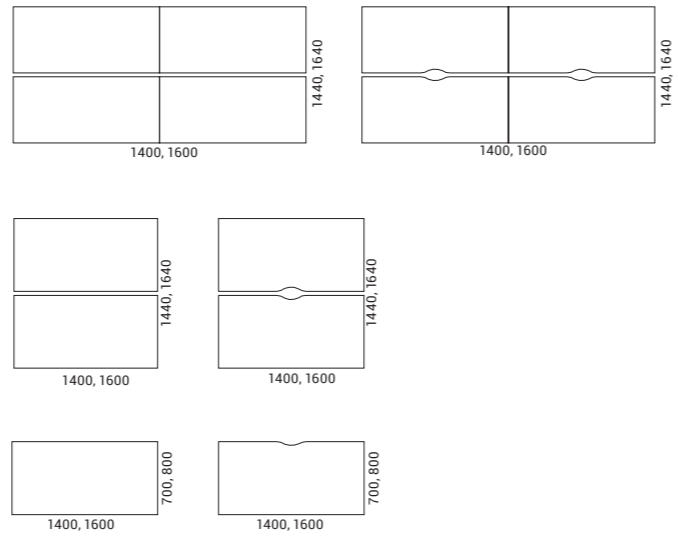

Clover-shaped teamwork desk

Bench desk with cut-outs for wire management has a clover-like shape. Ideal for setting up a work-space for a team of three people.

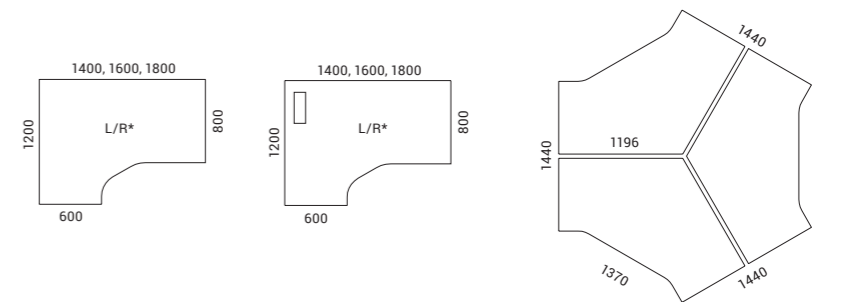

* - left/right

DESKS



AIR

Design by Gediminas Juška

CONFERENCE &
MEETING TABLES

> 80

EXECUTIVE
FURNITURE

> 326

Furniture that appears as if floating in thin air

An exceptional feature of AIR desks is thin metal legs that convey a sense of lightness and at the same time ensure their durability and stability.



62

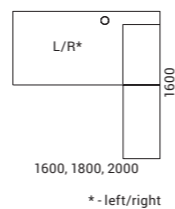
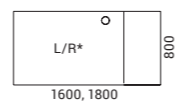
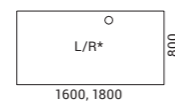
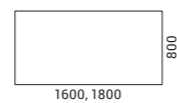

1600, 1800, 2000
* - left/right

To make even more efficient use of space, choose a cabinet suspended at hand's reach above the desk for storing personal items and office supplies.



63

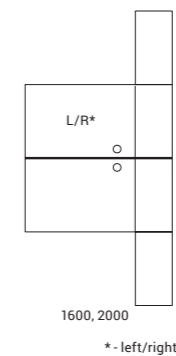
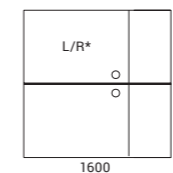
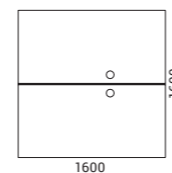
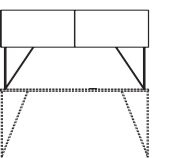

1600, 2000
* - left/right

Minimalist AIR designs, thought through solutions, combinations of different textures and colours – all this provides more creative freedom for architects who design office spaces.

DESKS

DESKS

“

I think that a modern workspace should be functional and light just like pristine nature, crystal-clear water and fresh AIR.”

Gediminas Juška



AIR

AIR

T-EASY

CONFERENCE &
MEETING TABLES

> 87

Desks that do not restrict the user's freedom of movement

T-EASY desks are ideal for the office workspace design combines fixed-height desks (H=740 mm) for shorter working periods, and ergonomic electric adjustable desks for regular work which allow the users to change their posture using the sit-stand principle.

66

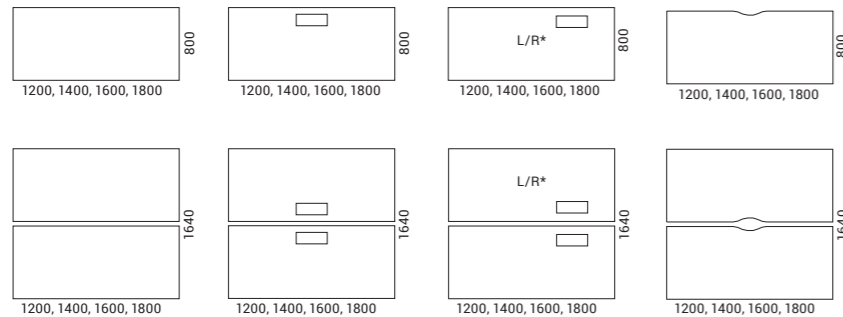

ONE H

Ideal for any office

While working at the desk with T-shaped legs, you will be able to enjoy a freedom of movement as there will be more space underneath the table and around it.

67

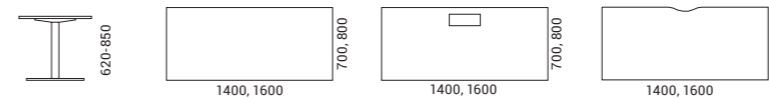

OPTIMA C

An optimal solution for your workplace



68

It allows you to create a comfortable, functional and well-organized work environment using minimum components. The desk has C-shape double cantilever legs and an insert for discreet management of wires and cables. Choose the type of desktop that meets your needs best.

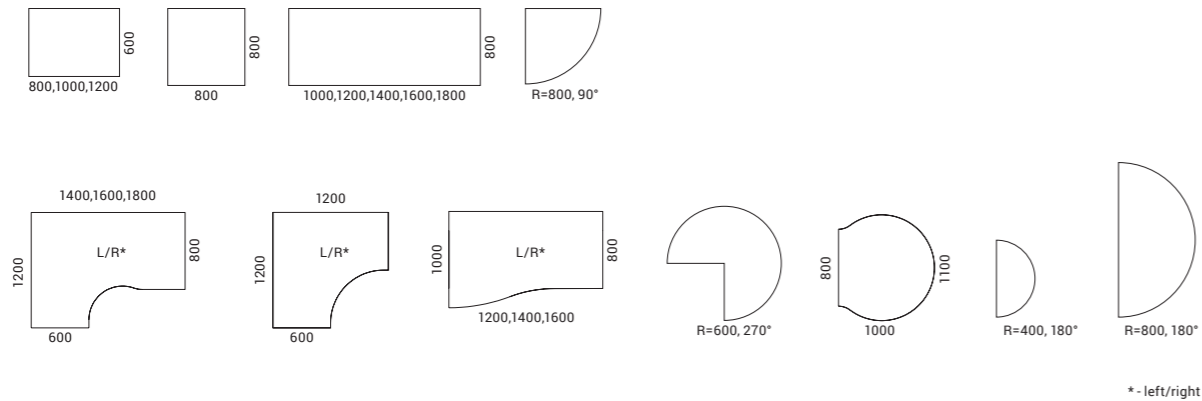

OPTIMA C

OPTIMA Plus



69

The system includes panel end legs with levelling feet which provides stability on uneven flooring. Choose the type of desktop that meets your needs best: a rectangular desktop, a desktop with left- or right-handed configurations, a corner desktop or a wave desktop.

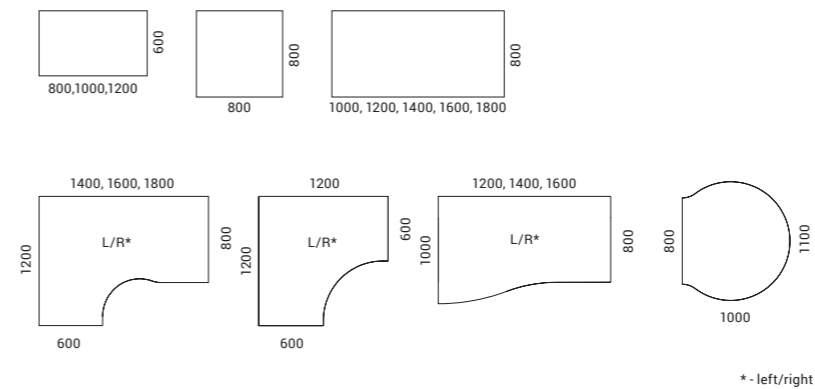

OPTIMA Plus

NOVA Wood

DESKS
> 48

HIGH
TABLES
> 90

OCCASIONAL
TABLES
> 94

NOVA Wood tables offer a subtle sense of luxury and create warm atmosphere thanks to their natural elements. The key distinct feature of these tables are elegant and uniquely patterned solid ash wood legs.

The meeting table has an ash tree veneer insert which is a well-thought out cable management solution for a meeting space.



reddot award 2019
winner



70

71

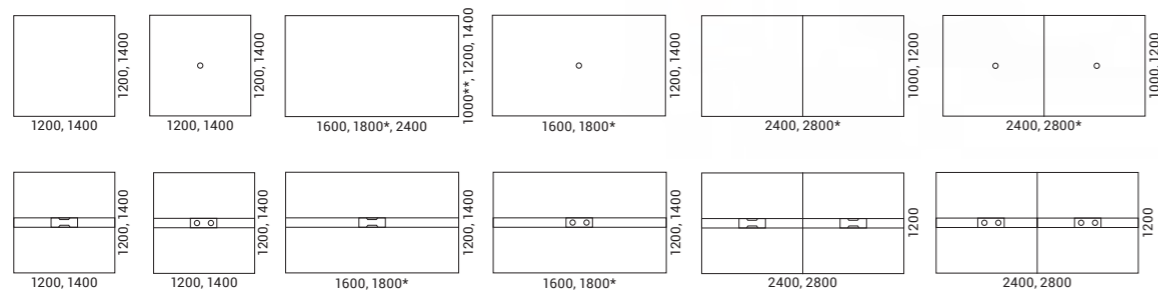

* - only 1200
** - only 2400

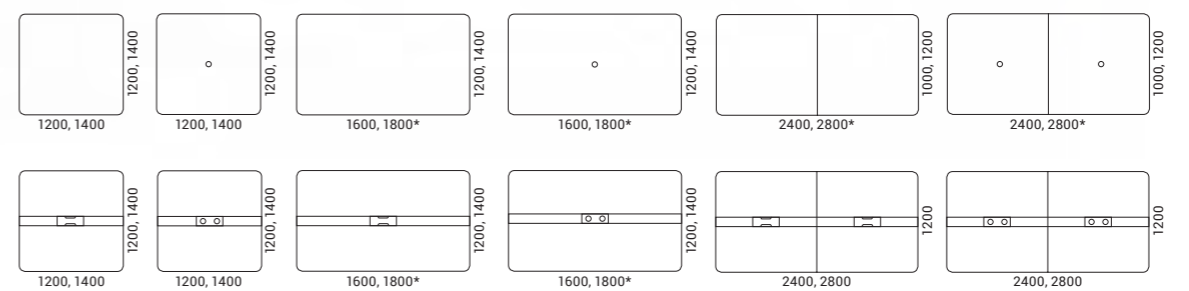

* - only 1200



STEP
L15

Design by Roberto Lucci & Paolo Pampanoni

Exclusive meeting tables

The Italian design of the tables is based on the harmony of straight and curved lines.

Quality is in the details

The rectangular tables come with soft closing grommet, beautifully framed in metal and concealing the box for wire management. This functional detail becomes invaluable in long meetings.

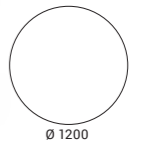

74

75

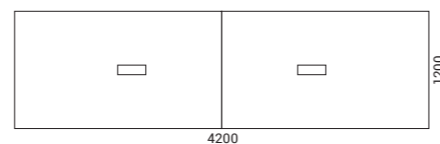
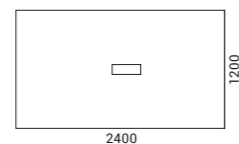

The elegant three-part curved steel legs are crafted using difficult technology and are the ultimate distinctive feature of the system. The solid thick tabletop increases the sturdiness and the visual impact of the tables.



76

77

A universal choice

Intelligently designed solutions allow you to create aesthetically pleasing and well-organized meeting areas.



78

Special desk inserts are functional and playful elements which can be of a different colour than the desktop and can efficiently conceal internet and power boxes. In addition, each cable under the table passes through horizontal and vertical cable ducts.

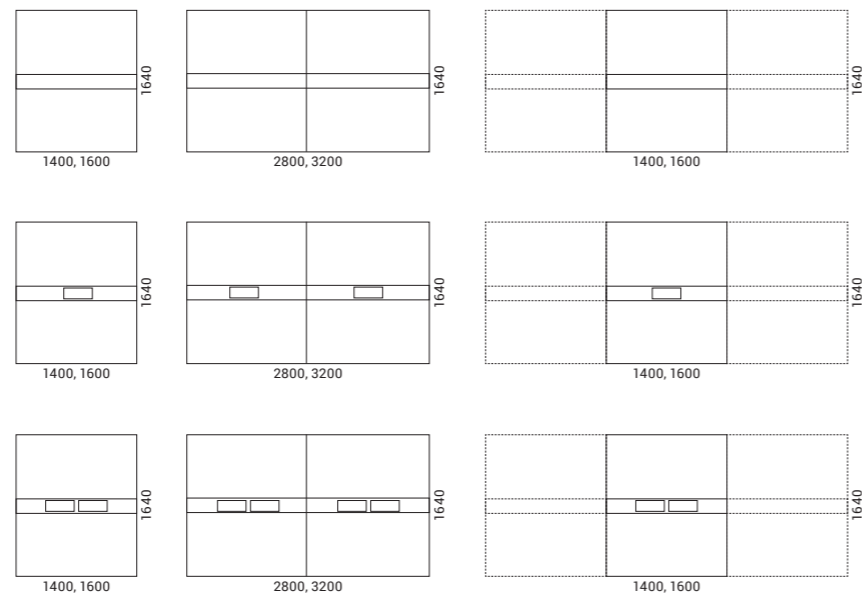

79

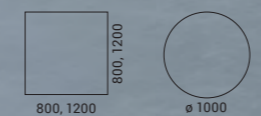

Meeting tables can accommodate 6 to 12 people but there is an option of setting up a desired number of workplaces using additional side panels.

**CONFERENCE
& MEETING
TABLES**

AIR

Design by Gediminas Juška

DESKS
> 62

EXECUTIVE
FURNITURE
> 326

AIR meeting tables offer a variety of different shapes and capacities ranging from round tables for a few people to rectangular tables which can be joined together to form a large conference space. These tables have an option for hidden cable management so you can keep the tabletop as tidy as possible while charging your laptop or mobile phone.

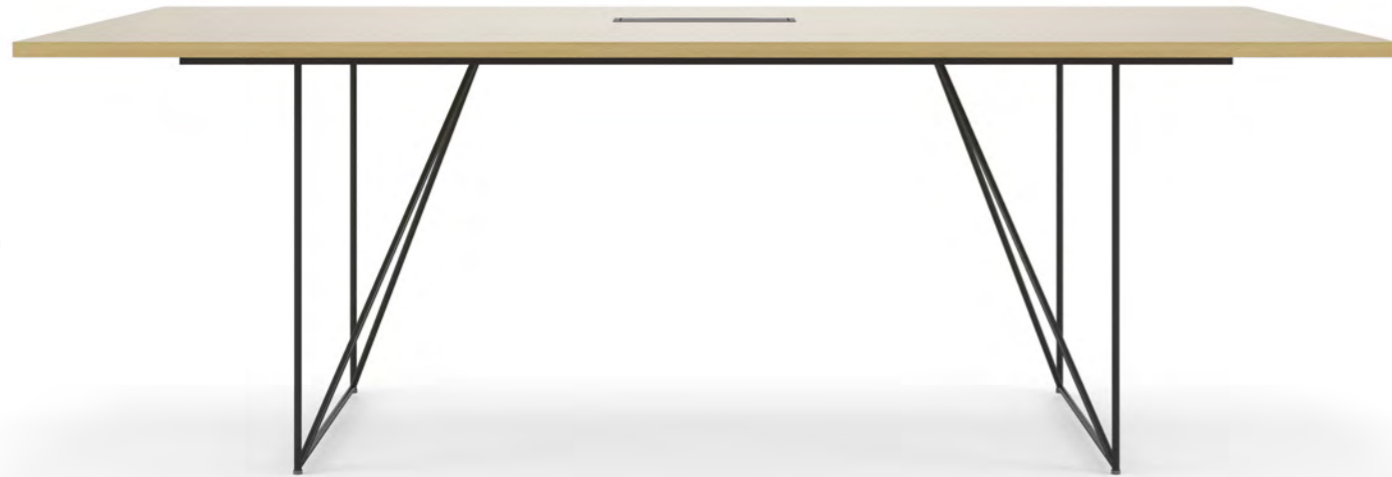

80

The central cover can be removed to reveal a channel that holds accessories and closed for a neat and tidy conference table.

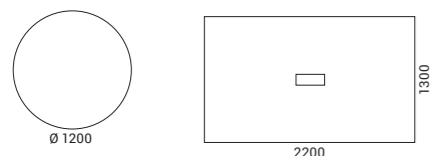

AIR



81

AIR

Let the work flow
with JAZZ

JAZZ meeting tables are ideal for various kinds of meetings as they are available both as height adjustable and fixed height tables.

82



The design of the height adjustable JAZZ meeting table is unique in that the base of the table is made of concrete. This type of table from the JAZZ line is ideal for short meetings, quick brainstorming sessions or simply enjoyable coffee breaks.

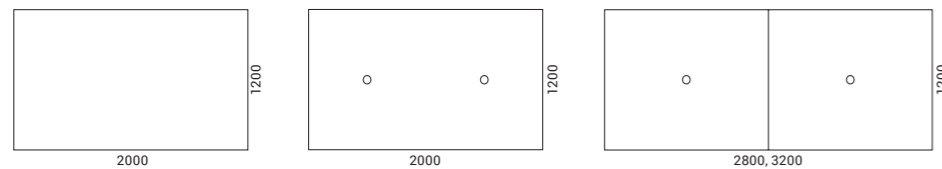

JAZZ



For regular meeting zones accommodating longer meetings, we offer fixed height desks featuring clean lines. These tables are ideal for a team of eight, ten or twelve people.

JAZZ

FLIP-TOP FLIP-TOP.II

Space-saving
meeting tables

A FLIP-TOP desk has a desktop that can be flipped up in a vertical position and comes with casters. This will not only enable you to save space but also easily prepare the office space for meetings, conferences, trainings or collaborative work.



84

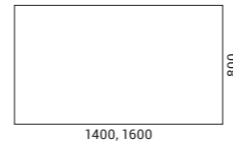

FOLDING

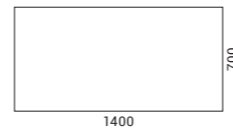

FLIP-TOP / FLIP-TOP.II / FOLDING



85

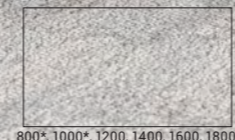

* only 600

FLIP-TOP.II

FORUM

OCCASIONAL
TABLES
> 99

Affordable, durable
and long-lasting
meeting tables



86

Round tabletops and bases ensure efficient use of the entire table area and facilitate communication with your colleagues and partners. Choose from our extensive range of table sizes to find an option that will offer the most comfort to you and meet your specific needs.

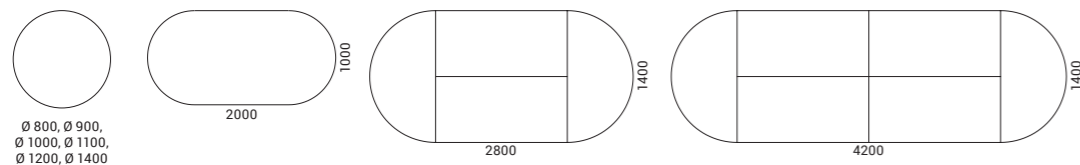

FORUM

OPTIMA

DESKS
> 68
OCCASIONAL
TABLES
> 99

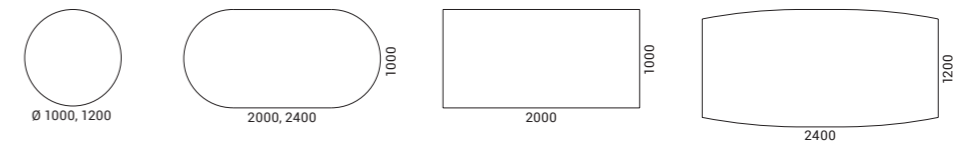

87

T-EASY

DESKS
> 66

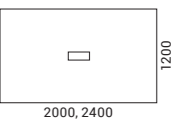

OPTIMA / T-EASY

MEDIA

A smart solution
for meeting areas

It gives you an easy way to show presentations and to participate in video conferences and meetings. The conference wall can be attached to various types of meeting tables or high tables. You can also choose MEDIA wall with a power socket and with a cable port for wire management.

88

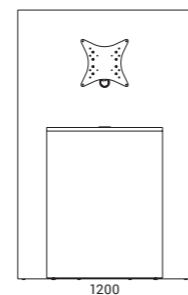
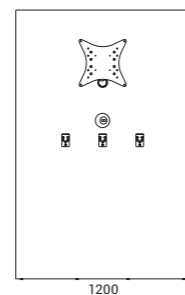
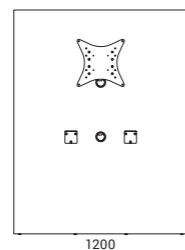
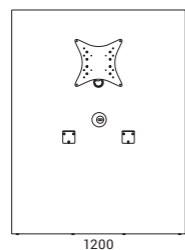

HIGH
TABLES

NOVA Wood

DESKS
> 48

CONFERENCE &
MEETING TABLES
> 70

OCCASIONAL
TABLES
> 94

A touch of nature
in your office!

Perfect for spontaneous meetings with colleagues or a short coffee break, the NOVA high meeting table can become a subtle accent and provide your office interior with some extra warmth.



90

Table height allows you to have a meeting in either sitting position while using high chairs, or standing position which increases the team's engagement, work efficiency, and even health. These tables can also be combined with conference walls, that will let you use multimedia devices while presenting or simply charge your laptop and phone.

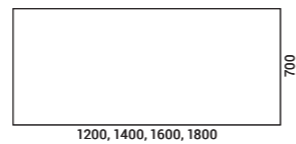
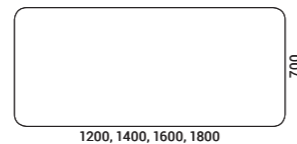

NOVA Wood



NOVA Wood

HIGH TABLES

NOVA

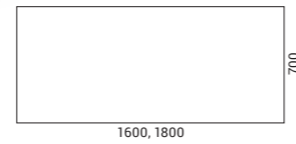
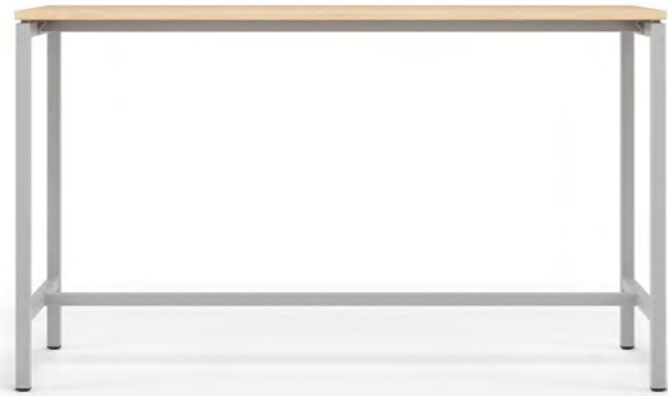

DESKS

> 54

CONFERENCE & MEETING TABLES

> 78

OCCASIONAL TABLES

> 98

EXECUTIVE FURNITURE

> 330

LIGHT

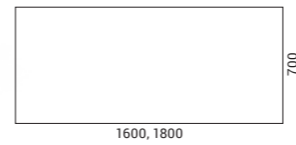
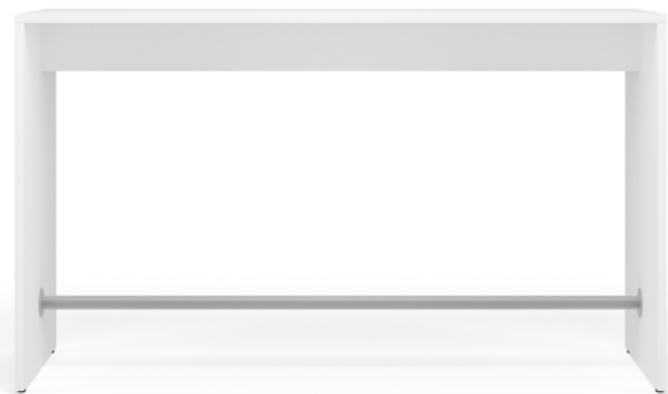

92

JAZZ

Design by Christina Strand and Niels Hvass

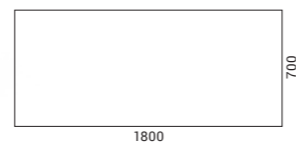
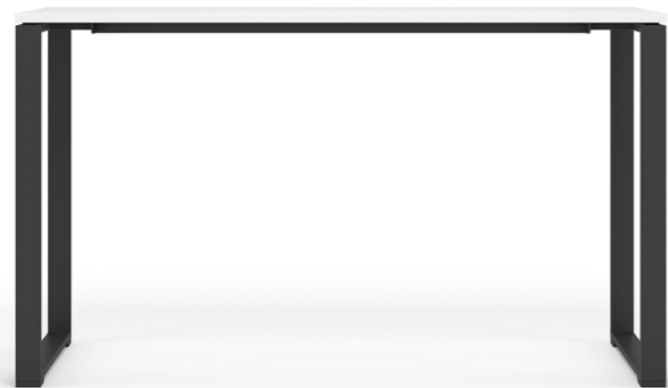

CONFERENCE & MEETING TABLES

> 82

NOVA / LIGHT / JAZZ

HIGH TABLES



OCCASIONAL
TABLES

NOVA Wood

DESKS
> 48

CONFERENCE &
MEETING TABLES
> 70

HIGH
TABLES
> 90

OCCASIONAL
TABLES

94



A well-designed and compact addition to any lounge area. These tables come in round and rectangular shapes which will definitely find a place in your interior.

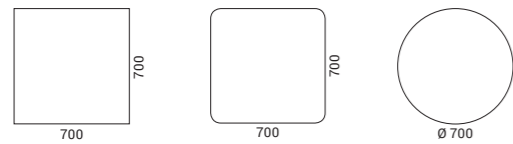

NOVA Wood

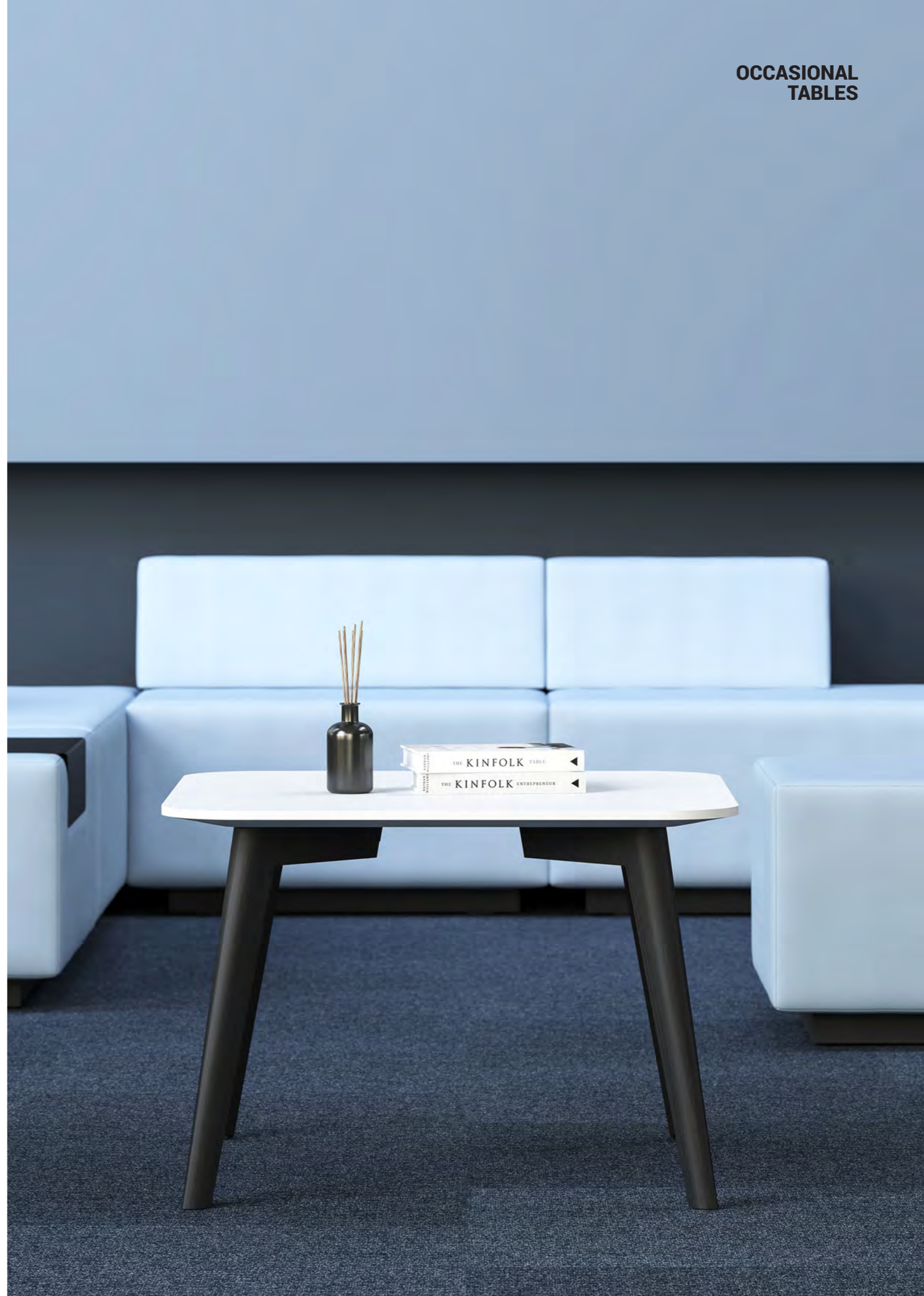

MOBI

AMBER



96

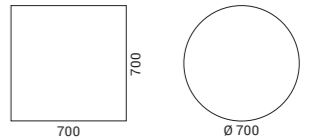

97

SITO

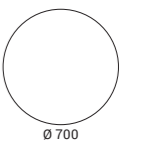
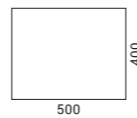

OCCASIONAL
TABLES

NOVA

DESKS

> 54

CONFERENCE &
MEETING TABLES

> 78

HIGH
TABLES

> 92

EXECUTIVE
FURNITURE

> 330

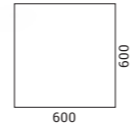

FORUM

CONFERENCE &
MEETING TABLES

> 86

OCCASIONAL
TABLES

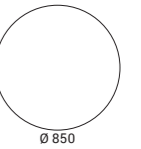

98

NOVUS

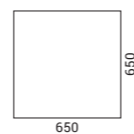

99

OPTIMA

DESKS

> 68

CONFERENCE &
MEETING TABLES

> 87

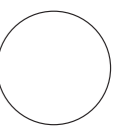
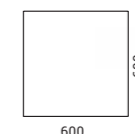

STORAGE

CABINETS



100

CHOICE

> 102

TOWERS



BOXI

> 118

LOCKERS



CHOICE

> 122

PEDESTALS



NOVA

> 130



UNI

> 110



NOVA

> 128



OPTIMA

> 131



NOVA

> 114

101

CHOICE

Your freedom of choice!

We offer a wide range of storage solutions and functionality thus you will be able to select or create customized cabinets best suited for your office space.

102



103

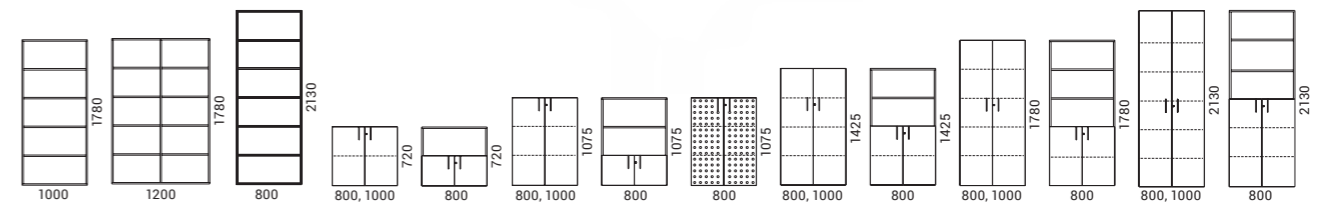
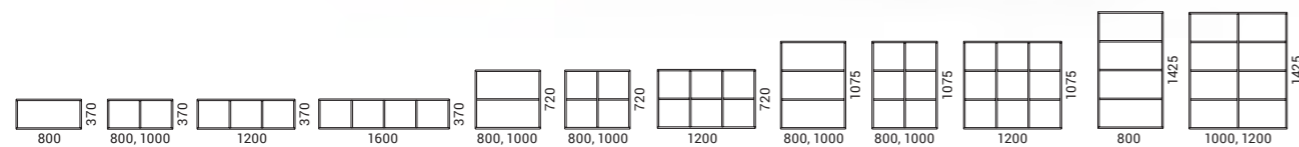

CABINETS

4 door types

Wide array of cabinets

The system of cabinets offers a choice from as many as 6 different cabinet heights, 4 options of doors and widths, and even 7 different types of bases. Enjoy a complete freedom to choose the one that suits you best!

You can use acoustic doors, cabinets with sliding doors, cabinets with hinged doors and open bookcase storage.

104

Metal baseboard or metal legs will be perfect for those who want to create a minimalist office style. Legs made of natural ashwood will bring you closer to nature in a very subtle manner. Castors will make it easy to rearrange office furniture. Each solution can be your best choice.



Open book cases Hinged doors Sliding doors Acoustic doors



4 widths



7 base types

CABINETS

6 heights



Practical approach

One of the greatest advantages of CHOICE storage units is that they offer a convenient and practical internal layout.

Endless combinations

You can easily create your own unique design by combining different cabinets. Also, a good idea is to combine different types of textures: tapestry, melamine and natural veneer. Choose from a wide range of materials and colors to create desired combinations that will blend nicely into your office.

106

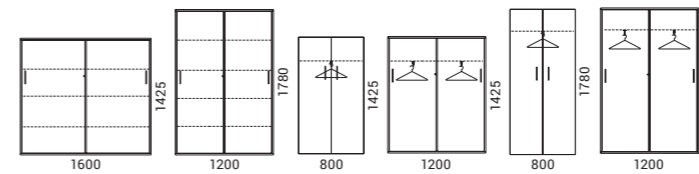
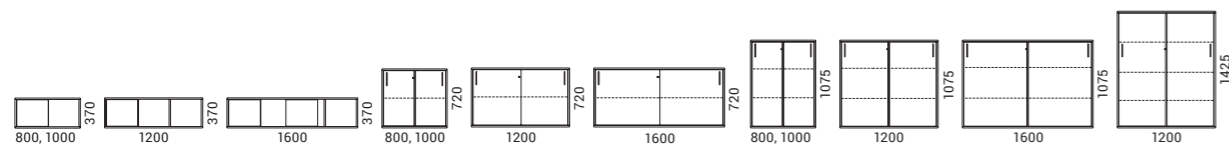



INTERIORS
THE FASHION BOOK

Well-organized storage of office materials

A large selection of accessories allow you to arrange the inside of the cabinets based on your individual needs.

110



111

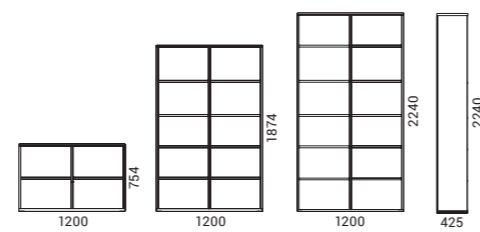
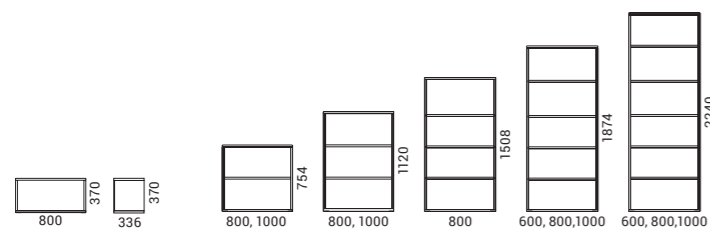

* - left/right

Colourful details

An upholstered back of the cabinet adds colour to your office space and absorbs noise. If you choose a cabinet with a special back suitable for writing on it, you will have an additional space to capture your ideas.

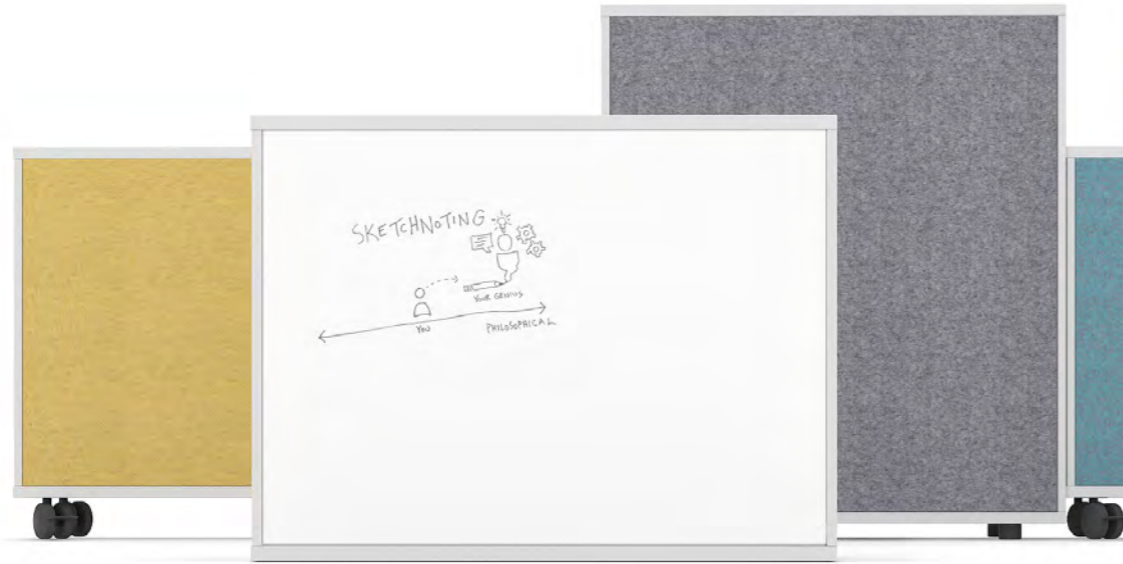

112

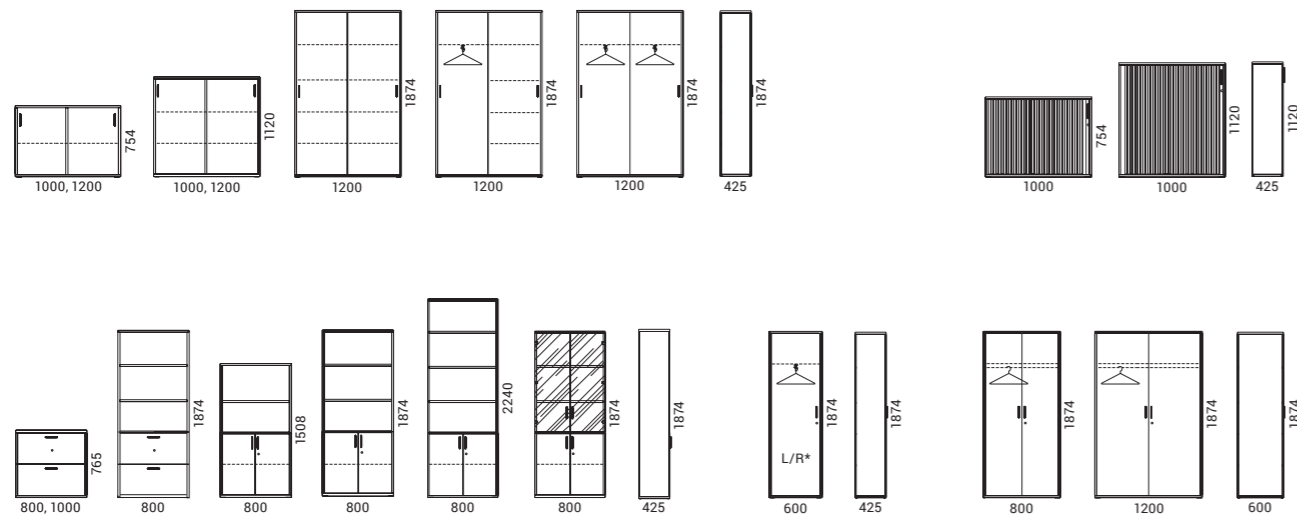

* - left/right



NOVA

Wonderful simplicity

Simple and ergonomic solutions are ideal for setting up large office spaces and help to create a coherent interior style.

114



115

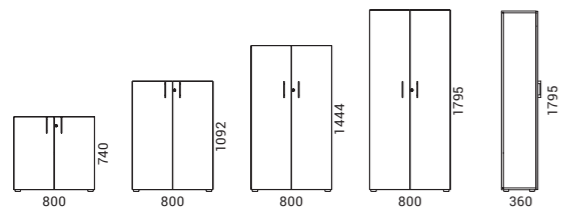

NOVA

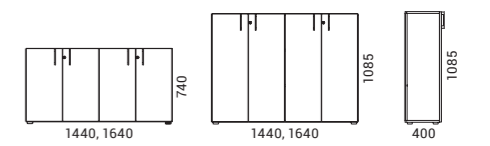
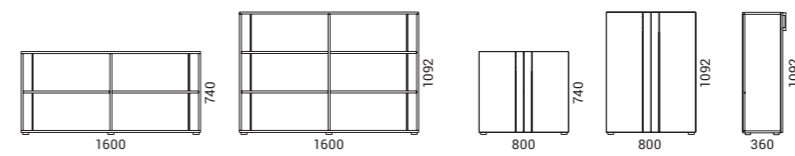
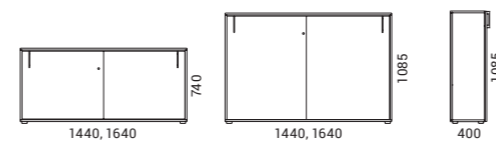
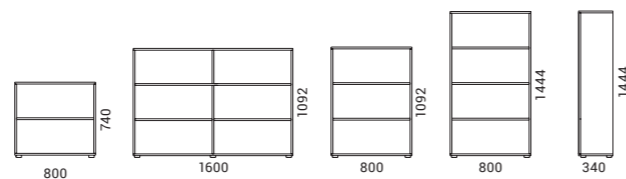

NOVA

CABINETS

Adapted to desk height

The height of the cabinets matches the height of the bench desks available in the product line.



116

Decorative elements

Choose decorative acrylic glass inserts and handles for your cabinet to add a nice touch to it.



NOVA

CABINETS



BOXI

Minimalist style – unlimited possibilities

BOXI storage tower is a simple and universal solution designed to accommodate all office essentials for the daily needs in the office.



118



* - left/right

BOXI

Flexible arrangement of work spaces

Choose a preferred tower height: a 740 mm storage tower can serve as an extension to a fixed-height desk, whereas 1090 mm or 1200 mm options will be a great addition to the sit-stand desks or can be used as a workspace divider. BOXI storage towers with shelves can have either right-hand or left-hand configuration thus they can be easily re-arranged if you decide to change the workspace layout.



119

All storage towers are available in two depths of 800 mm or 820 mm, thus they can be combined with single desks or bench desks.

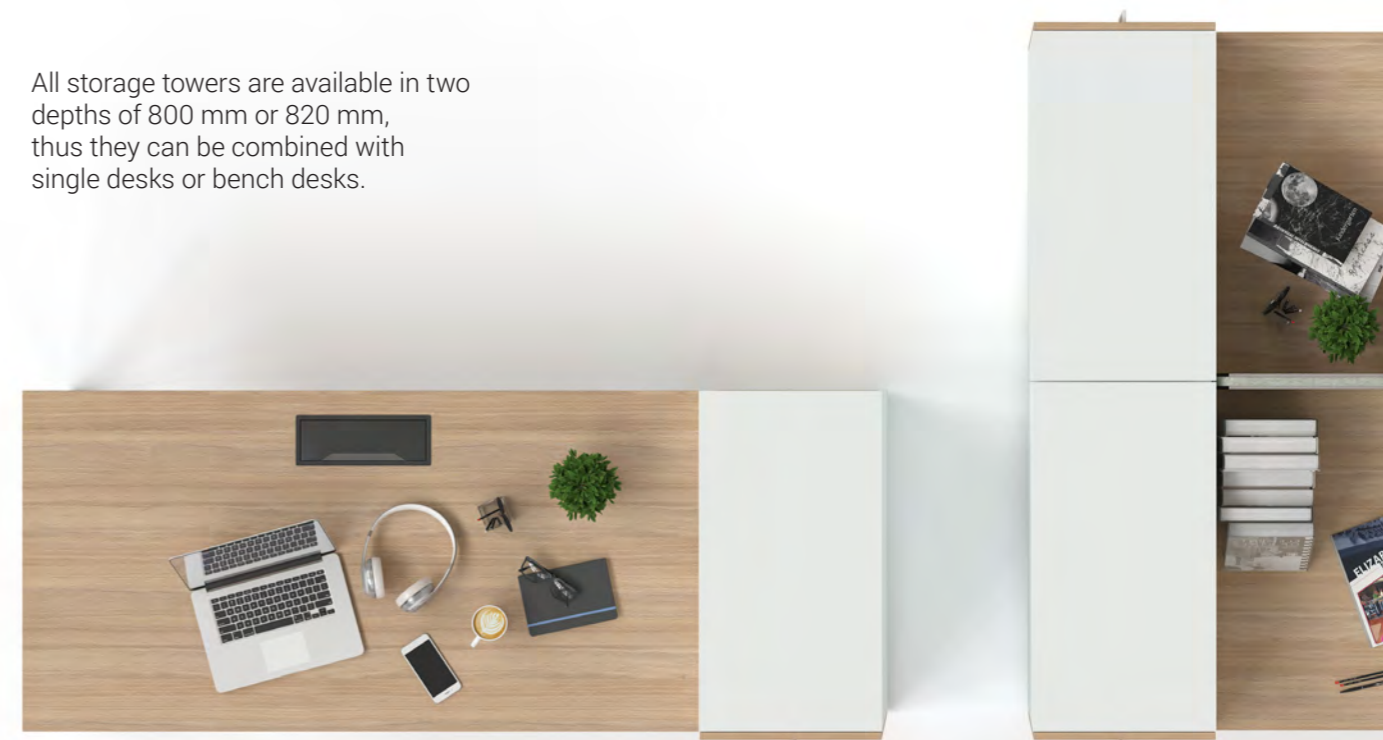

BOXI

TOWERS

Make the most of all available options

Choose spacious shelves or universal file drawers, small shelves with an upholstery lining or small drawers for storing small items. BOXI storage towers with USB or plug sockets will allow you to charge your mobile devices.



Visual versatility

Mix and match various melamine covers or use a planter box to transform the BOXI storage towers into green islands with flourishing greenery which will be a great way for employees to rest their eyes during a break.

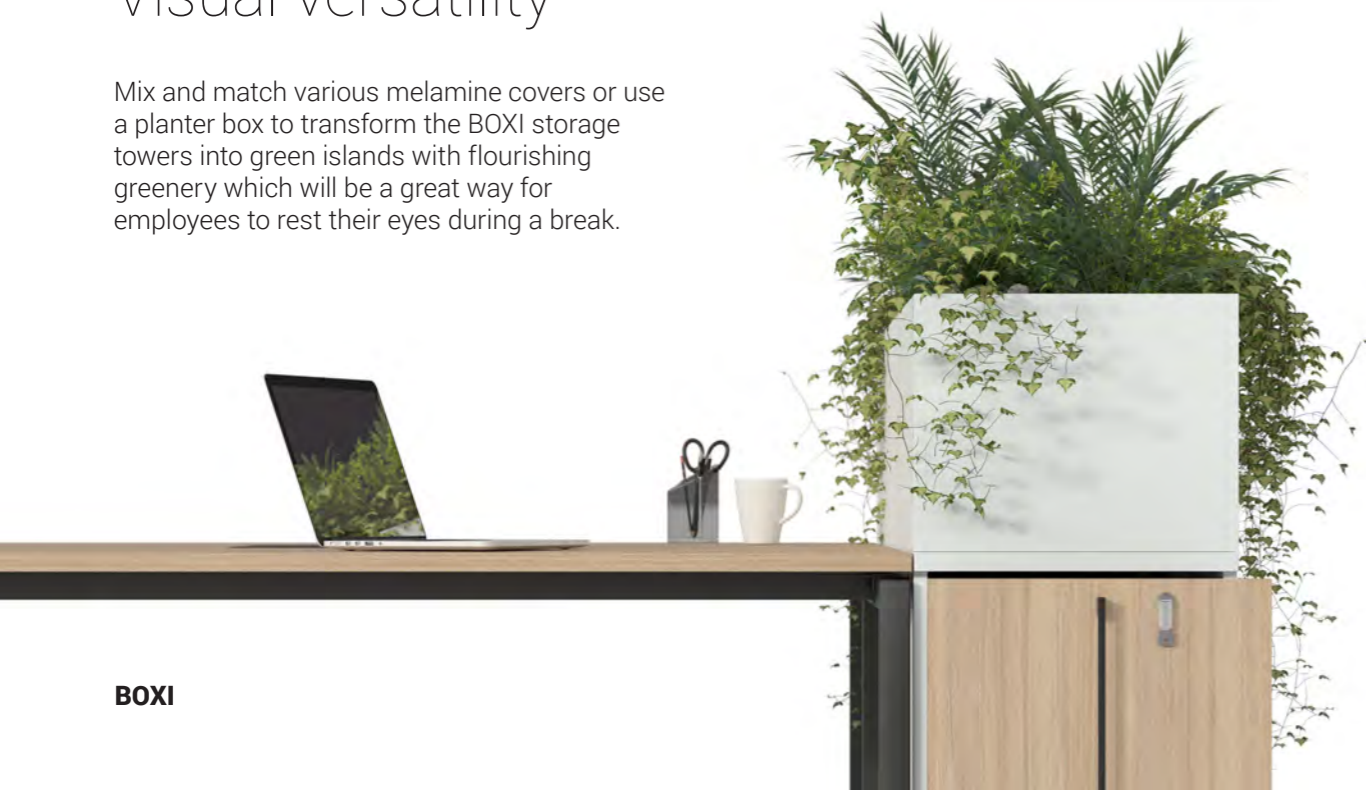

Essential attribute for shared spaces

Modular locker cabinets are a versatile solution for secure personal and office items storage, temporary or all-day use. CHOICE lockers can be useful for both resident and mobile workers or office visitors.

122

Modular system

Create the most suitable combinations for various spaces by combining CHOICE locker modules of the same height (917 mm / 1367 mm / 1817 mm). Also, you can combine doors of two heights (450 mm / 900 mm) and different types – the standard and with cut-out for mail or air circulation.

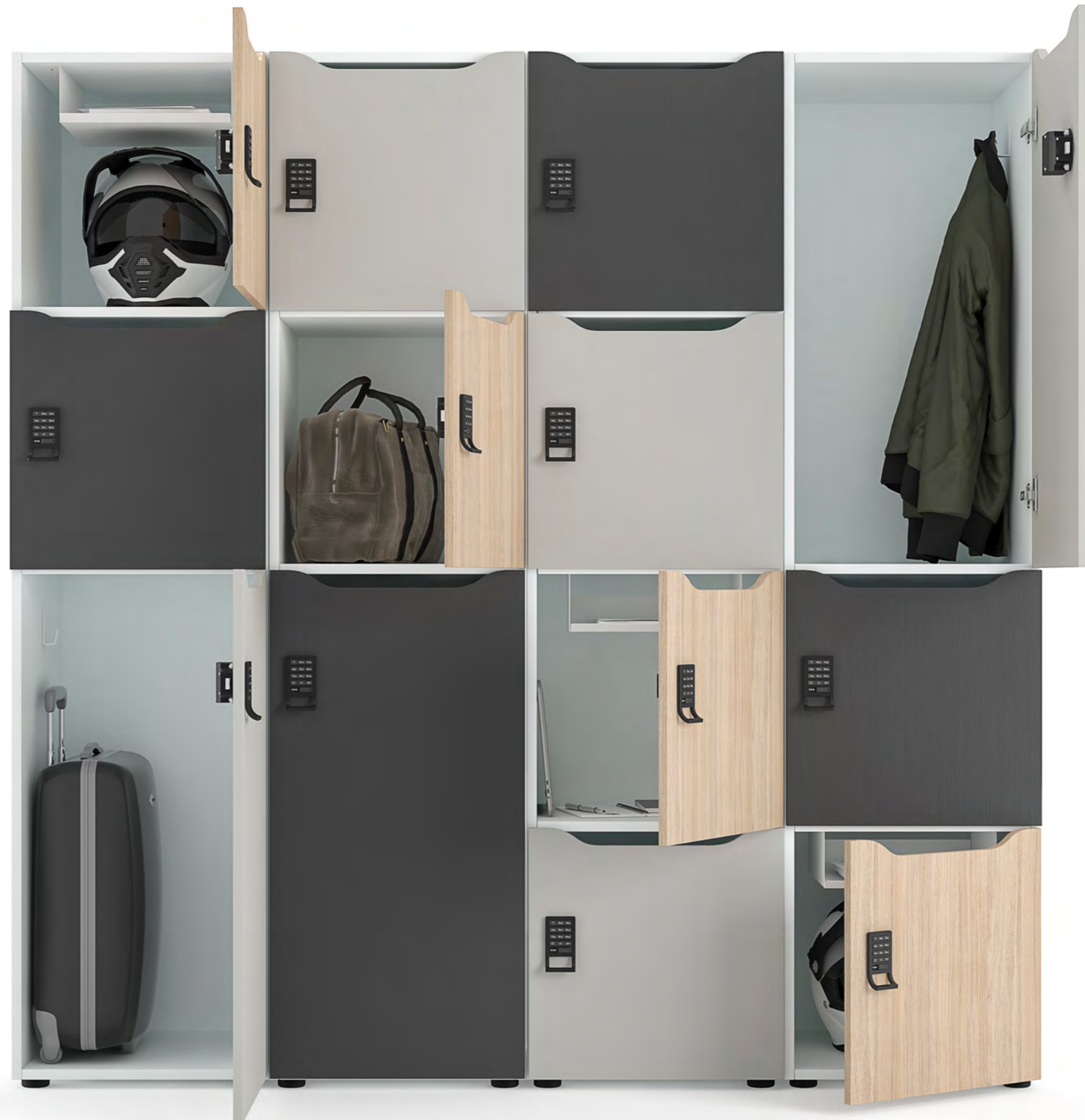

123

Personalized lockers

A variety of sizes and box types fulfils different needs – from storing small personal and work tools to big-size items. Customize your locker by using additional items such as metal shelves, name card holder or hook for clothes.



4 types of locks

Along with the traditional key locking, we offer also a combination lock and electronic locks (opened by a code or a card). Lockers with electronic locks can be assigned for personal use or be used by different users for temporary needs.



125

Colourful combinations

Locker is a great tool to express your company's culture. It could be the place where you add brand colours to your office space.

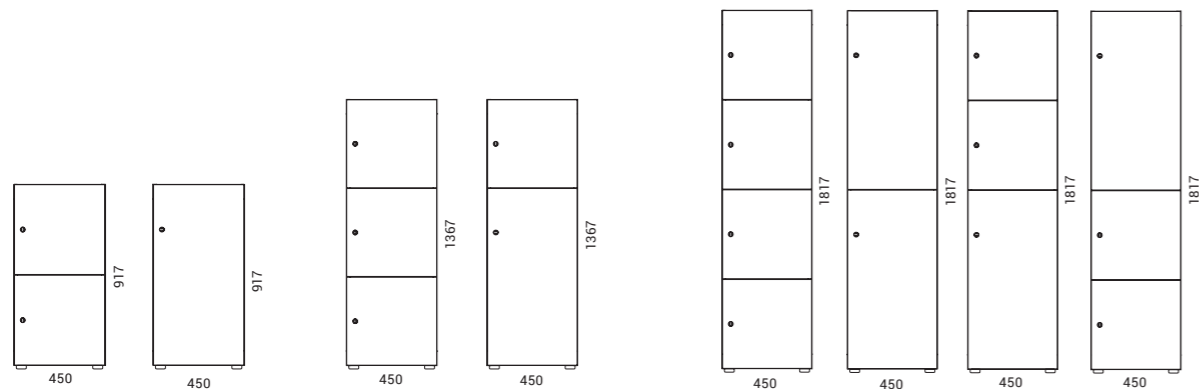

CHOICE

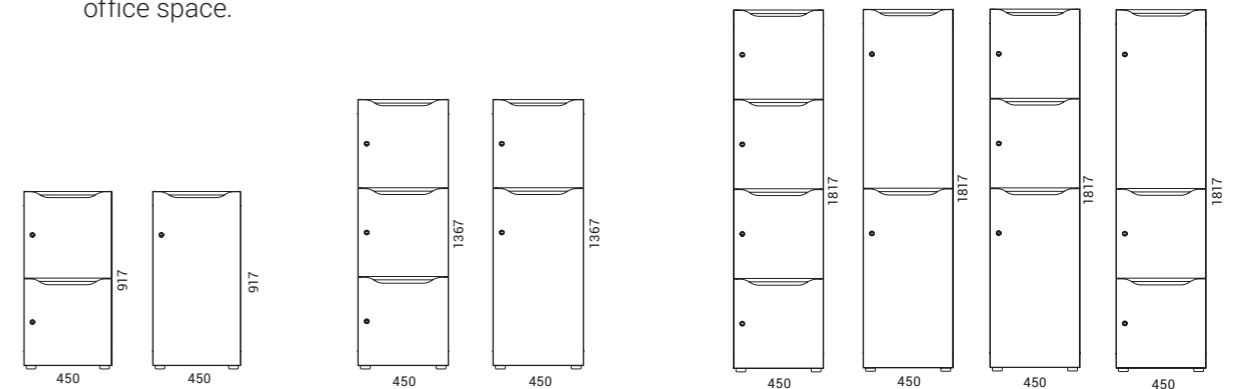

CHOICE



CHOICE

CHOICE

LOCKERS

NOVA

CABINETS PEDESTALS

> 114 > 130

A privacy feature for any workplace

NOVA is a simple and cost-effective storage solution. With heights of both 1092 mm and 1444 mm, these lockers feature either 6 or 8 compartments. Each compartment is lockable for keeping personal items secure. Locker doors and carcasses are available in a range of Melamine finishes which allows you to easily fit this furniture to the desired office design.

128

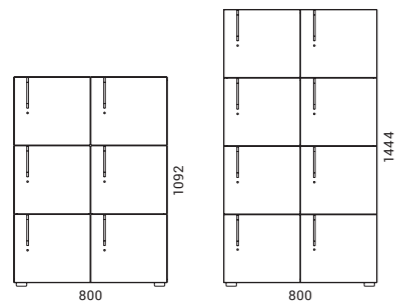

NOVA

LOCKERS



NOVA

NOVA

CABINETS > 114
LOCKERS > 128

Universal storage cabinets

We offer suspended cabinets, mobile under-desk cabinets or fixed desk-height cabinets. Cabinets can come with conventional drawers or hanging file drawers.

130



Customizable design

Design options featuring minimalist handles or no handles allow you to create a neat and "clean" office space. You can also add a playful touch to your workplace by combining different colours of doors or cabinet frames or by incorporating a cushion so that employees could take a seat on the cabinet for a short rest break.

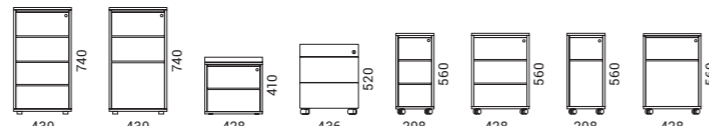

OPTIMA

Essential furniture for every workplace

OPTIMA pedestals will definitely expand your workspace and provide convenient storage for files and small items. You can choose from desk height, under desk or mobile pedestals based on your needs and preference. Clear design and high functionality will make OPTIMA pedestals a great addition to any personal working area.

131

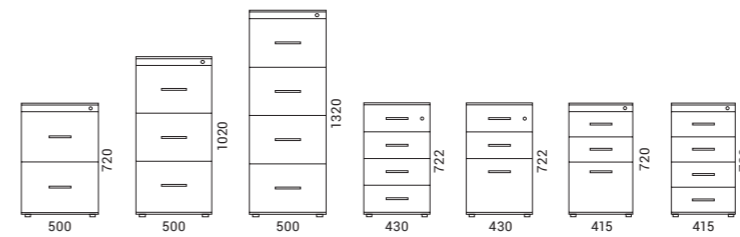

ACOUSTIC SOLUTIONS

ACOUSTIC PODS



SILENT ROOM
> 134

ACOUSTIC SCREENS & PANELS



FREE STANDING
> 142



MODUS
> 146



MODUS Light
> 148

ACOUSTIC DESK SCREENS



ROUND PET
> 150



MODUS
> 154



DESK 760
> 156



TOP 530
> 158

ACOUSTIC FURNITURE



JAZZ Silent Box
> 160



MY SPACE
> 164



ARCIPELAGO Wood
> 170

ACOUSTIC
PODS

SILENT ROOM

Choose SILENT ROOM acoustic pods to create functional work areas by dividing or opening interior spaces as necessary. This piece of furniture can be set up in the middle of the office space, near the walls or partitions or inside a wall niche maintaining a clearance of just 300 mm at the top for air circulation.

ACOUSTIC
PODS

S

L

M

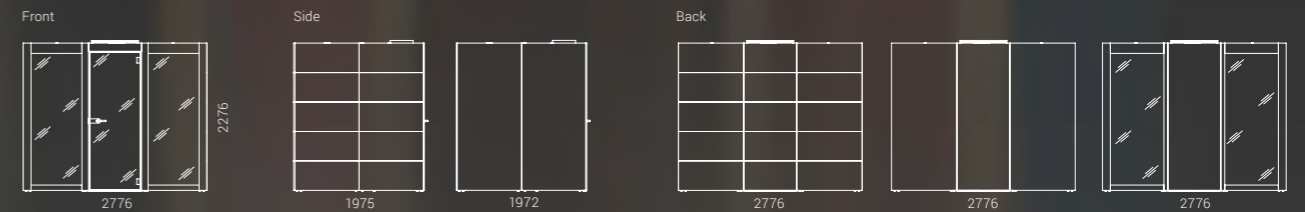
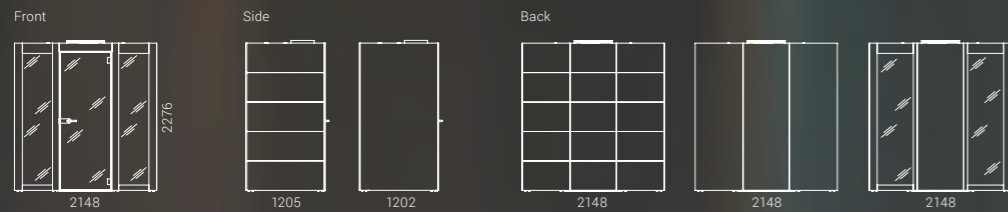

SILENT ROOM

SILENT ROOM

Less noise, less chaos

Multilayered SILENT ROOM wall structure, hermetic door and ceiling ensure sound insulation. The inner layer of the panels is made from high-class acoustic material that eliminates echo and has excellent sound absorption properties. The upholstered exteriors block out noise effectively and create an acoustically-optimized working environment.

Creative freedom to customise your design

SILENT ROOM offers a variety of design options for you to be able to create a personalised design and desired office mood. The interior and exterior finish can be selected separately. Both melamine and upholstery can be used for the exterior panels.

A powerful ventilation system installed at the floor level and in the ceiling of the SILENT ROOM acoustic pod efficiently removes excess heat and high levels of CO2 concentration. A smart control unit selects an optimal ventilation and illumination level, and, if necessary, allows for individual adjustment. Once an employee leaves the SILENT ROOM, intense ventilation is automatically activated to prepare the room for the next user.

136

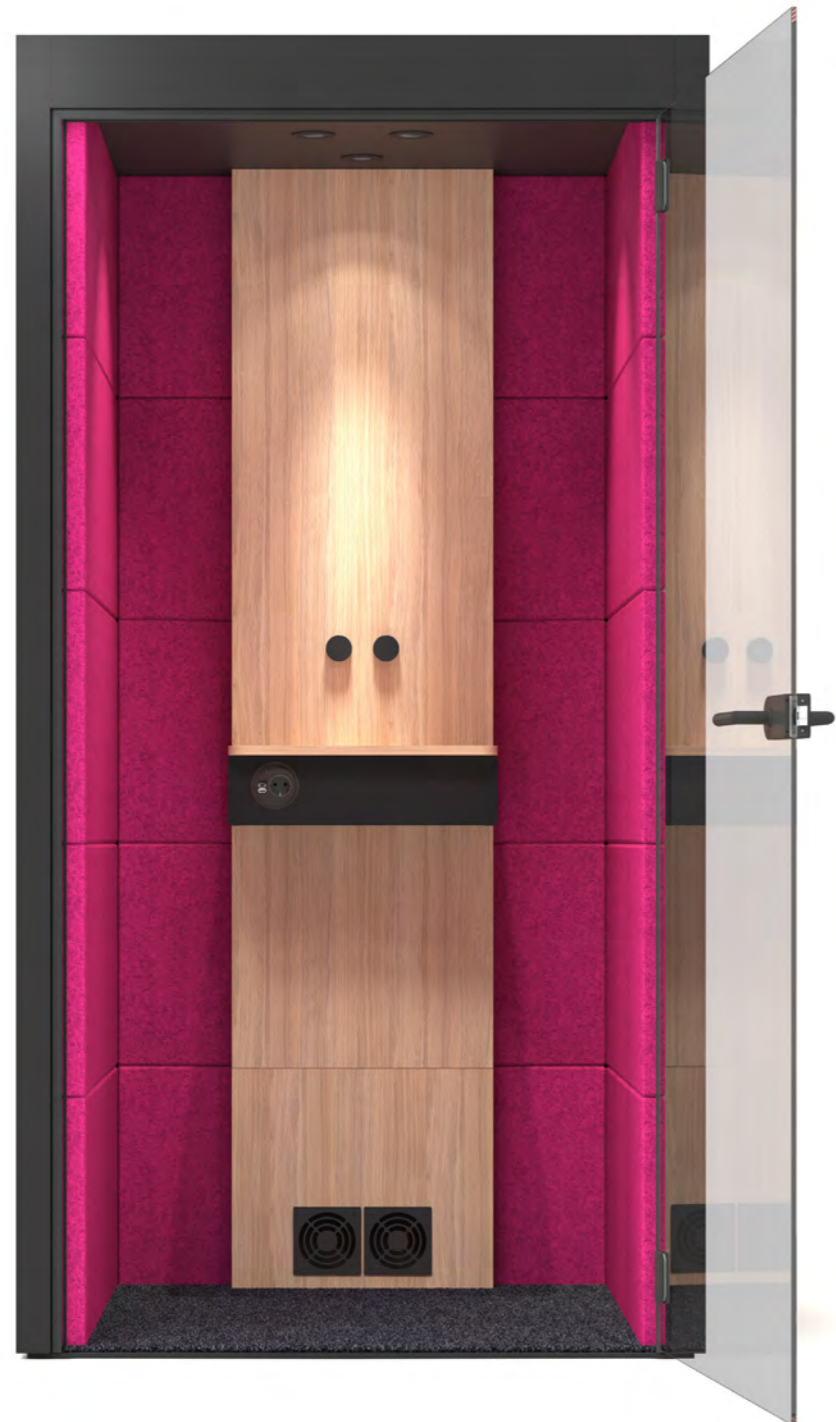

SILENT ROOM

137



SILENT ROOM

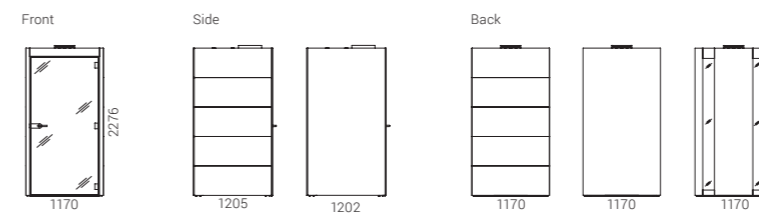

SILENT ROOM is easily adapted to a variety of activities. The acoustic pods come in three different sizes with selectable options such as glass back-wall inserts, high or standard tables, seating, monitor holders, etc.

For users' convenience, the room can be equipped with a power outlet (USB type A and C connectors) or 3-plug power block. The power block can come with in-built sockets, LAN or USB ports in various configurations.





FREE STANDING

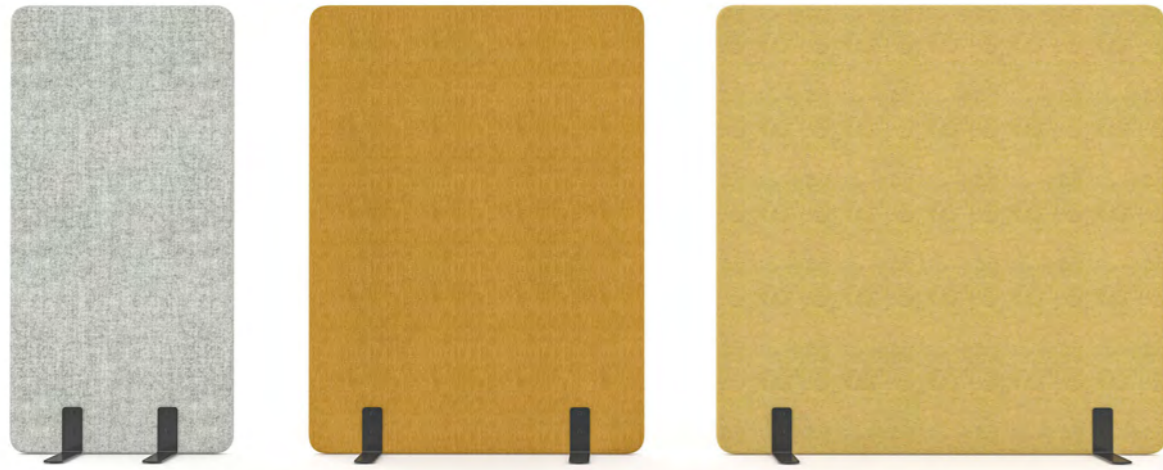

142

Multifunctional acoustic screens

FREE STANDING acoustic screen system offers unlimited possibilities to divide your office with visual and acoustic barriers and even quickly create new areas for specific types of activity.



FREE STANDING



Thanks to their simple configuration, these acoustic screens allow you to easily divide your office space into desired areas. You can choose free standing screens with support feet or mobile screens on casters. The panels are available in a broad selection of sizes and can also serve as workspace dividers.

The screens are filled with a special sound-absorbing foam and provide a class C sound absorption. They can be upholstered with the fabric of your choice. The special connectors can be used to combine, align and hold the screens in place.

144

145



FREE STANDING

FREE STANDING

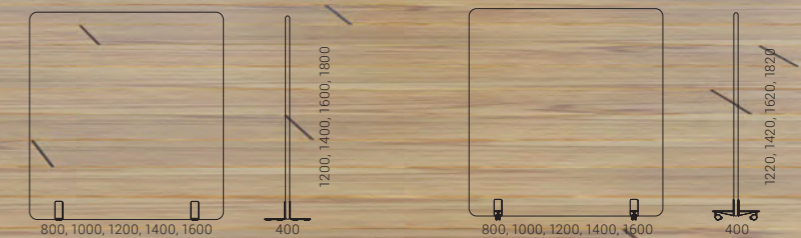



146

MODUS acoustic panels will improve your working environment and workplace well-being by absorbing background noise and by creating acoustically private spaces as well as bringing character to the interior space. The acoustic panel system includes wall panels, ceiling (horizontal) panels, and ceiling (vertical, double-sided) panels.

The panels come in different sizes, as large as 1200x1200mm, and are very easily joined together. The panels contain a special patented and certified material designed to efficiently absorb sound.

Double-sided (vertical) panels

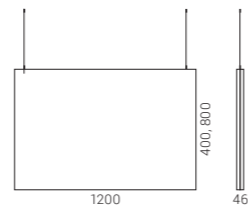

Wall panels

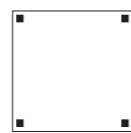

Ceiling (horizontal) panels

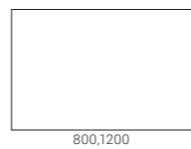

You can choose acoustic panels with different fabric colours on each side to create your own unique interior design. Select from from six different sizes and mix and match different panel depths (40 or 70 mm).

MODUS Light

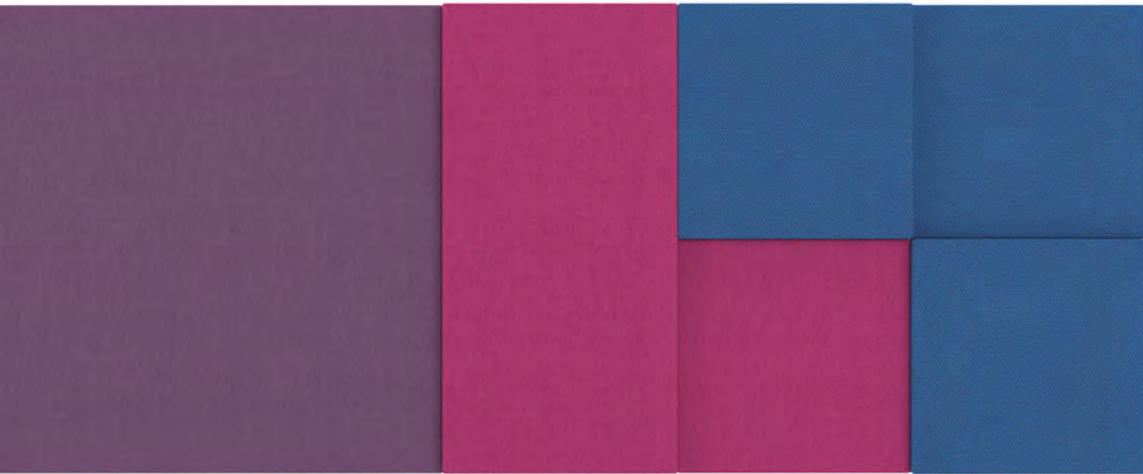

148

Acoustic comfort in open-plan offices

MODUS Light are lightweight, sound-absorbing wall and ceiling panels that improve office acoustics and serve as an inspiring and functional interior solution.

Panels are made of acoustic foam offering class A (for a 68 mm panel) or class C (for a 48 mm panel) sound absorption.

Thanks to their lightweight design, these acoustic panels are easy to transport and easy to install. MODUS Light are available in three design options: wall and ceiling panels, hanging panels, and Armstrong ceiling panels (integrated or hung on a wire rope). The panels have multiple different fitting options and can be attached to a number of surfaces, even glass.

Implement your creative ideas by using acoustic panels of three different sizes and two different depths. You can also choose from our wide range of fabrics and a variety of colour options.

Acoustic panel with metal fittings to be fixed to suspended ceiling "Armstrong"

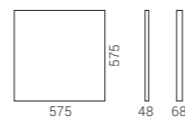

Wall panels

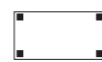

Ceiling (horizontal) panels

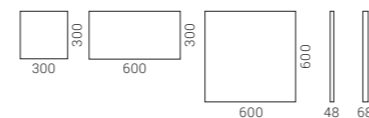

ROUND PET

A sustainable solution for acoustic comfort and privacy

ROUND PET acoustic desk screens are an excellent solution to ensure a greater level of privacy and acoustic comfort for employees, while at the same time giving them sufficient freedom to share their ideas with other team members. The product encourages circular economy as it is made from recycled materials and it is also suitable for recycling.



150



ROUND PET

PET felt features

This sustainable material possesses excellent sound absorption properties. PET felt is soft and light, yet strong and durable material is ideal for desk screens. Due to the structure PET felt can be easily cleaned and disinfected.

SCREEN PATTERN TYPES

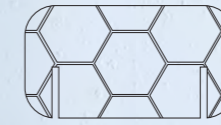

SCREEN TYPES

For fixed desktops



Mobile



For sliding desktops

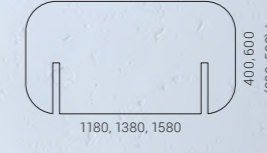

* - screen height above the desktop

Rounded design sequel

ROUND PET acoustic screens are a part of ROUND desk system. Therefore, they share the rounded shapes as the main design element.



151

ROUND PET

ACOUSTIC
DESK
SCREENS



Privacy and comfort at the workplace

Height-adjustable or fixed-height MODUS acoustic desk screens will offer both privacy and sound absorption sheltering users from general office noise.



154



515-660 mm
screen height above the desktop.

MODUS

MODUS acoustic desk screens are double-sided. Thanks to this construction, you will be able to choose a combination of two different colours.

Height-adjustable screens will allow you to adjust the height of these acoustic screens by releasing and tightening the metal holders. Choosing a fixed-height will ensure a uniform look of the workspace even with one employee standing and another sitting at the desk.

The screens provide Class D sound absorption. Class C sound absorption is available for MODUS desk screens specifically designed for our MOTION two-desk benches.

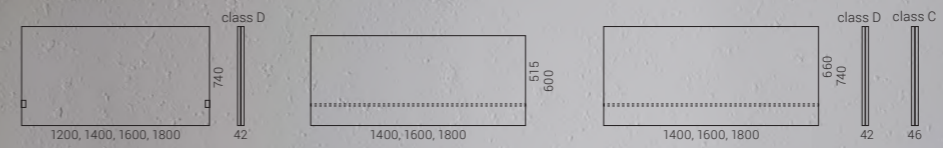

Height adjustable screens suitable for desk systems:
ACTIVE, single MOTION desks, single EASY desks, ONE, NOVA A, T-EASY, ONE H

Screens suitable for MOTION bench desks with leg columns type 2.
515 mm - screen height above the desktop.

Screens suitable for MOTION bench desks with leg columns type 3.
660 mm - screen height above the desktop.



MODUS

DESK 760

Privacy without isolation

The DESK 760 acoustic panel system improves visual and sound comfort of the workplace without separating team members from one another thus allows them to communicate freely. The system offers screens to cover all sides of the desk. Thanks to a wide range of colour options and functionality, these panels work well in various spaces.

156



DESK 760

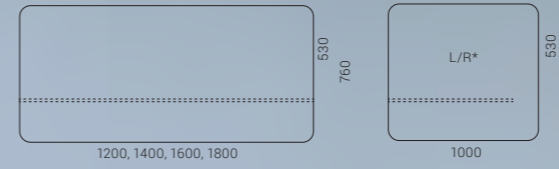

Screens suitable for desk systems:
NOVA U, NOVA H, NOVA A, NOVA O, EASY,
T-EASY, ONE, ACTIVE, AIR, NOVA Wood
(Melamine; only single desks)

* - left/right



DESK 760

Acoustic comfort and privacy at the workplace

TOP 530 acoustic desk screens add privacy to your workplace and absorb background office noise. This solution enables employees to better focus on their tasks yet still allows communication and doesn't separate team members from one another. The system offers screens to cover all sides of the desk.

Because of the sound-absorbing material TOP 530 acoustic desk screens have a class C rating for sound absorption. The screens are perfect for both single desks and bench desks and come in a variety of colours and materials to match any interior.

158

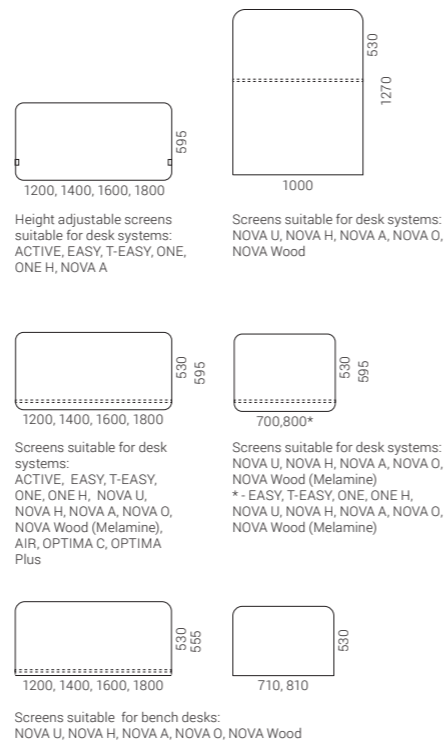

JAZZ Silent Box

Design by Christina Strand and Niels Hvass

LOUNGE
& SOFT
FURNITURE
> 294



160

A private and quiet space for meetings

JAZZ Silent Box is a quiet place of retreat in your office environment designed for meetings, brainstorming, individual work or relaxation. JAZZ Silent Box is made of special sound-absorbing material which delivers class D sound absorption.

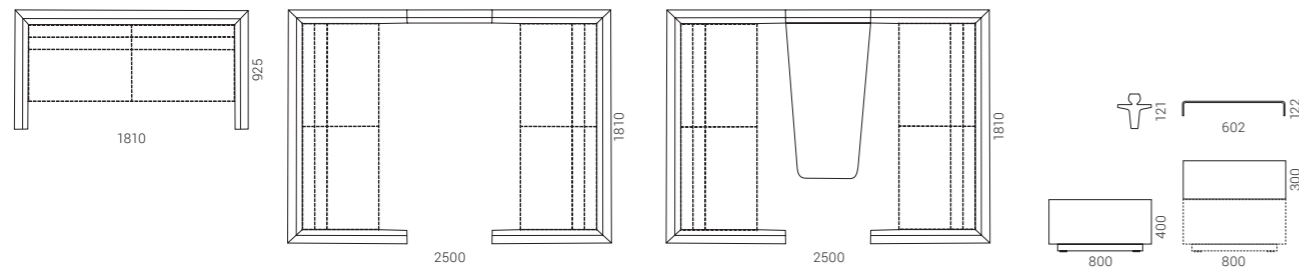

JAZZ Silent Box



Silent Box option with a table and a monitor holder will enable you to work on your computer conveniently and to display visual information on the screen during meetings. The furniture can also be equipped with a power outlet and a USB connection.

JAZZ Silent Box



162

163

Choose the acoustic walls of JAZZ Silent Box without the integrated soft furniture or table. Place your own customized combination of furniture within the acoustically pleasant and private environment of JAZZ Silent Box.

MY SPACE

Create your space
with MY SPACE

From private mini-rooms for concentration to collaboration areas for teamwork, this system provides a comfortable workplace, allows you to distance yourself from ambient noise, and opens up new "office-within-office" possibilities.



164

Proven acoustic
characteristics

MY SPACE is a great choice to reduce the overall noise level of the office as the acoustic screens are filled with a special sound-absorbing foam and covered with upholstery of your choice.



165

Make your office stand out

Different size and shape desktops make MY SPACE a flexible solution for almost any working environment while height-adjustment function helps create a convenient workplace for individual tasks.

Thanks to the modular construction, this acoustic furniture allows you to electrify up to 6 workspaces with a single power socket. MY SPACE is available with a 3 socket power unit that can be used for standard power supply, USB, or LAN connection in different configurations.

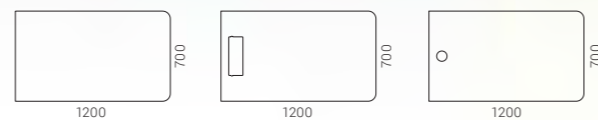
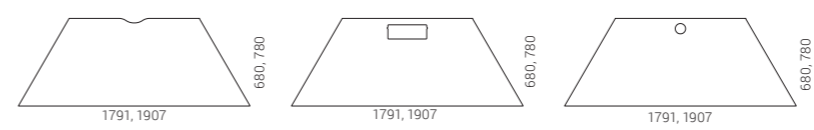
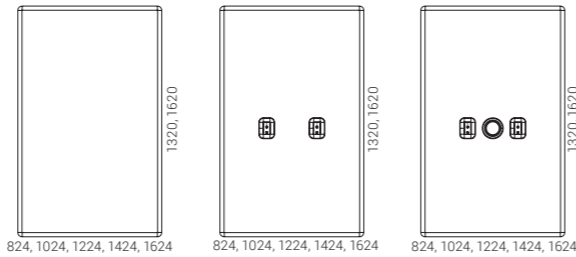

You can choose different interior and exterior colors for MY SPACE screens. Use your desired color combinations to create individual spaces or group workspaces.

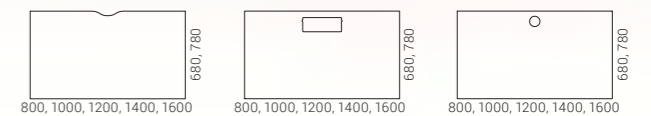



168

169

MY SPACE

MY SPACE

ACOUSTIC
FURNITURE

ARCIPELAGO Wood

Design by Baldanzi & Novelli designers

LOUNGE
& SOFT
FURNITURE

> 288

Escape busy office environment

ARCIPELAGO Wood lounge seating is ideal for creating an enclosed "room within a room" in open-plan offices. It serves as a meeting and work space where you can isolate yourself from ambient noise. This lounge seating is ideal for multiple uses: brief tasks or longer work sessions, meetings, teamwork or relaxation.

170



ARCIPELAGO Wood

Design

ARCIPELAGO Wood has been designed by the Italian design studio Baldanzi & Novelli Designers. Aesthetic design, smooth shapes and natural elements bring a sense of warmth to the office.

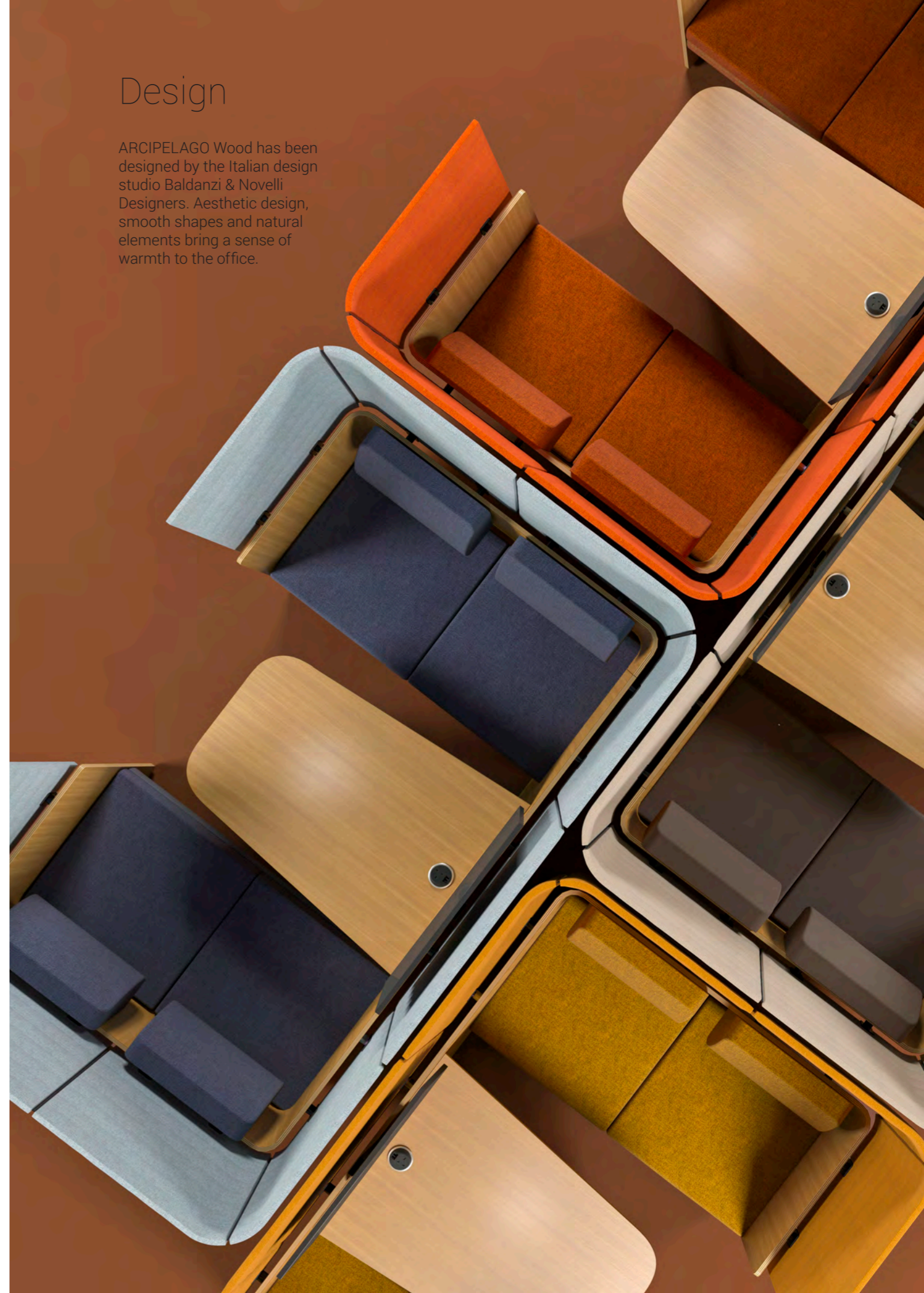



Functionality

The seating unit can accommodate a monitor screen for convenient presentation of information during business meetings. The table is equipped with a power socket with integrated USB type A and C connectors for any work devices to make sure you never run out of energy.

173

Comfort

Baldanzi & Novelli Designers who created ARCIPELAGO Wood compares this piece of furniture to an island which offers a natural retreat. ARCIPELAGO Wood high panels serve as barriers shielding employees from background noise while comfortable seating creates a laid-back and private environment.

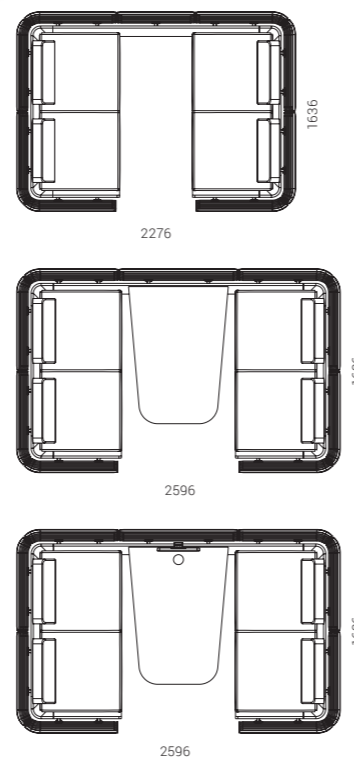

ACOUSTIC
FURNITURE



CHAIRS

TASK CHAIRS



SURF
> 180



EVA
> 198



DIVA
> 206



WIND
> 186



EVA.II
> 200



AURA
> 208



NORTH CAPE
> 194



MOON
> 204



VERSO
> 209

176

HIGH SWIVEL CHAIRS



SWAY
> 210



WIND
> 214

EXECUTIVE CHAIRS



NORTH CAPE
> 218



AURA
> 224



EVA.II
> 226

177

VISITOR & CONFERENCE CHAIRS

HIGH CHAIRS



WIND
> 228



MOON Wood
> 244



DIVA
> 252



TWIST&SIT
> 256



TWIST&SIT
> 232



WAIT
> 246



AURA
> 254



MOON
> 258

178



NORTH CAPE
> 236



GAMA
> 248



VERSO
> 255



MOON Wood
> 258

179



MOON
> 240



EVA
> 250



WAIT
> 260

SURF

An excellent design and undeniable sitting comfort

When it comes to style and comfort there's no need for compromise. This chair offers it all. Its main distinctive feature is an appealing backrest silhouette resembling a windsurfing sail. The backrest and lumbar support were created by the German designer Justus Kolberg.

180

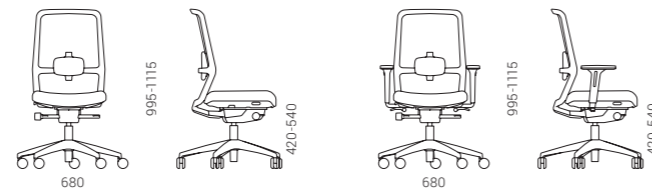

Unique mesh

The mesh design combines functionality and aesthetics. It is a breathable, soft and light material with a special 3D structure. A wide mesh colour palette expands the possibilities of creating the perfect fit.



Fine-tune your comfort level

SURF task chair provides great comfort and allows users to stay focused even after long hours of work.

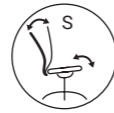

SYNCHRO
MECHANISM



BACKREST TRAVEL
LIMITATION



LOCKING
POSITIONS



TENSION AD-
JUSTMENT



ADJUSTABLE LUMBAR
SUPPORT

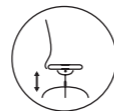

PNEUMATIC HEIGHT
REGULATION



ADJUSTABLE
ARMRESTS



TASK
CHAIRS

TASK
CHAIRS



SURF

SURF

WIND

Design by Baldanzi & Novelli designers

HIGH
SWIVEL
CHAIRS > 214

VISITOR
CHAIRS > 228

“

We felt the need to give this product a decisive character – an element defining its identity. Thus, we came up with an idea to create a back support made from a transparent and flexible material and to make it an anthropomorphic shape instead of a technical shape which would be pleasing to the eye and as clear as the wind blowing onto the sails of a ship or making leaves tremble.”

Baldanzi & Novelli designers

186



WIND family of chairs offers a combination of ergonomic features, functionality and unique design. Task chairs, high swivel chairs and visitor chairs designed for dynamic and efficient work and collaborative use are ideally suited for modern office spaces characterized by a unifying and unique WIND design.

188



WIND



Unique lumbar support

WIND has an instantly recognizable X-shape transparent lumbar support uniquely designed to enhance the chair's visual appeal and serve a very important function. Its height can be adjusted and it conforms to the user's lumbar shape due to the elastic properties of silicone to provide exceptional comfort.

189

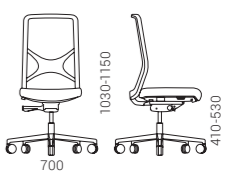
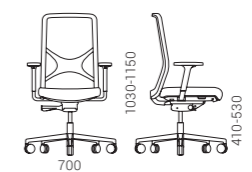
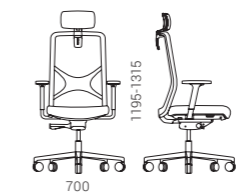
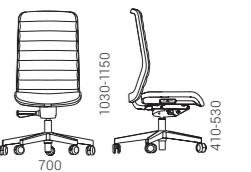
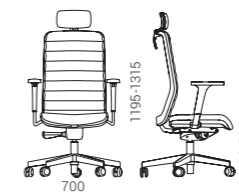

WIND

3 types of backrests

The backrest with a flexible mesh easily adapts to the natural shape of the user's spine. The aesthetic breathable mesh material ensures all-day comfort, no matter what seating position you use.



Fabric / leather look

The upholstered backrest is shaped with the principles of ergonomic seating in mind to ensure maximum workplace comfort. Its polyurethane insert with uniquely designed horizontal seams on both sides gives a totally different character to the chair. The backrest comes in a variety of upholstery options.



Micro-mesh

Choose a backrest with a unique knitted mesh created by an Italian design studio Baldanzi & Novelli designers. The mesh design pattern follows the X shape to further enhance the lumbar support that creates the WIND chair's identity. The knitted mesh is made using cutting-edge technology which allows us to manufacture chairs with seamless backrest corners so no scrap material is left behind.



Knitted-mesh

Simple and intuitive adjustments

WIND encourages an ergonomically correct sitting position and provides the functionality you need. Thanks to its simple and intuitive adjustment, the chair can be easily adapted to individual user needs and offers maximum comfort for long stints at the desk.



SYNCHRONOUS MECHANISM



WEIGHT-SENSITIVE MECHANISM



SLIDE SEAT



LOCKING POSITIONS



ADJUSTABLE LUMBAR SUPPORT



HEADREST

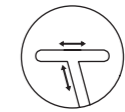

ADJUSTABLE ARMRESTS



TASK
CHAIRS



WIND

WIND

NORTH CAPE



Design by Baldanzi & Novelli designers

EXECUTIVE CHAIRS > 218
VISITOR CHAIRS > 236

Stylish, modern and adaptable

NORTH CAPE design is a combination of simple but at the same time strict lines and soft curves. Rectangular armrests made of polyurethane fit the backrest harmoniously. Unique, laconic curve of the backrest fluently going down to the line of the seating part, creates a subtle silhouette of the chair, which has already become the identity of this chair.

194

-  KNEE TILT MECHANISM
-  TENSION ADJUSTMENT
-  LOCKING POSITIONS

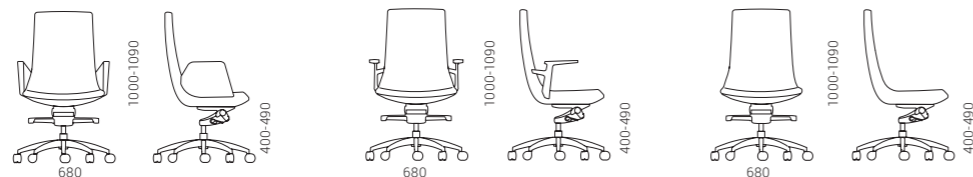

“

When two different cultures with the same goal meet, a wonderful result is achieved. The aim of the project was to create a chair, having an exceptional identity, which would combine and reveal Italian and Lithuanian styles.”

Baldanzi & Novelli designers



TASK
CHAIRS







Graceful style work chair

The chair's name EVA is a female name derived from the Hebrew name, meaning "life", may also have the meaning "lively". This is exactly what this task chair is, whose graceful shape is emphasized by the integrity of the backrest and seat.



The EVA task chair has a tilting mechanism, it means that the backrest and the seat are connected, and when the backrest is reclined, the whole chair tilts. For the convenience of the user, the backrest can be locked in four different positions.

-  TILT MECHANISM
-  TENSION ADJUSTMENT
-  LOCKING POSITIONS
-  LUMBAR SUPPORT
-  ADJUSTABLE ARMRESTS

198



Easy to feel comfortable

The back of the chair with a light, breathable polyester mesh adapts to the curves of the back and ensures comfortable support and constant air circulation. A stiffer plastic mesh for the back provides more support. The model with height-adjustable lumbar support - even better adapted to the shape of the user's back.

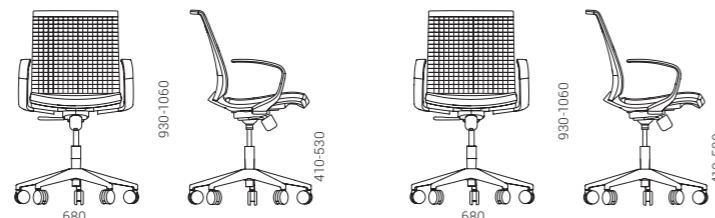

199



Contemporary universal task chair

EVA.II's impetuous modern design, wide range of functionality and universal features make it a great choice for work environments both in the office and at home.

200



SYNCHRONOUS MECHANISM



TENSION ADJUSTMENT



LOCKING POSITIONS

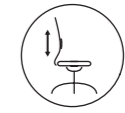

ADJUSTABLE LUMBAR SUPPORT

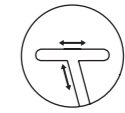

ADJUSTABLE ARMRESTS

Comfortable backrest

The backrest with a light, porous polyester mesh moulds itself to the curvature of the user's back, ensuring comfort and constant airflow, while a firmer plastic mesh grants additional support. For a yet even better fit to the the shape of the user's back we recommend EVA.II with height-adjustable lumbar support.



201

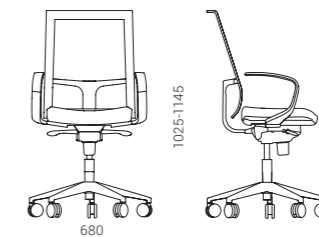
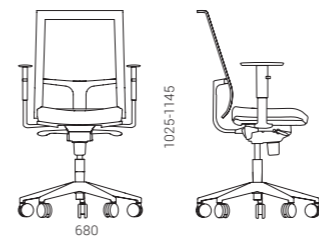



TASK
CHAIRS

MOON

VISITOR
CHAIRS
> 240

HIGH
CHAIRS
> 258

MOON chair integrate perfectly into the modern office environment, in which does not dominate, but by choosing brighter color solutions – it may become a stylish interior accent.



204

For a shorter working day

The user will be able to quickly and easily adjust the chair for a comfortable seat, and start work immediately.



TILT
MECHANISM



TENSION
ADJUSTMENT

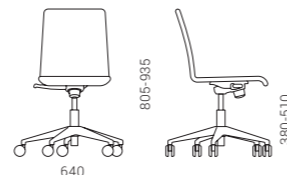

MOON

TASK
CHAIRS



MOON

Guaranteed ergonomics

The main goal of this ergonomic chair is to become an indispensable partner for the user during the working day, ensuring dynamic sitting positions, exceptional comfort, and ease of use.









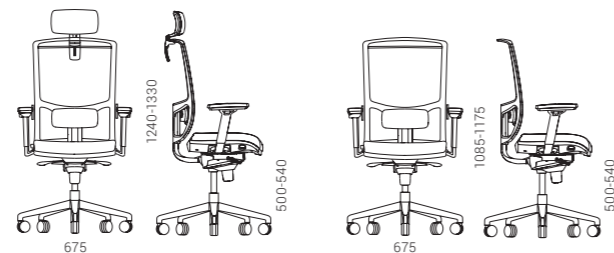

206



The chair is available with either black polyamide or polished aluminum 5-star base with castors. Thanks to its simple and intuitive design, DIVA can be easily adapted to individual user needs.







207

-  SYNCHRONOUS MECHANISM
-  TENSION ADJUSTMENT
-  BACKREST HEIGHT ADJUSTMENT
-  SLIDE SEAT
-  LOCKING POSITIONS
-  ADJUSTABLE LUMBAR SUPPORT
-  HEADREST
-  ADJUSTABLE ARMRESTS

AURA

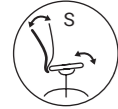
EXECUTIVE CHAIRS
> 224

VISITOR CHAIRS
> 254

-  SYNCHRONOUS MECHANISM
-  TENSION ADJUSTMENT
-  LOCKING POSITIONS
-  SLIDE SEAT
-  ADJUSTABLE ARMRESTS



208



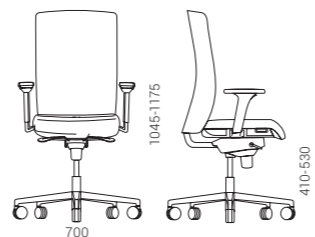

AURA

AURA is designed to let you find a comfortable position for work as well as for relaxation. The seating part and the backrest are soft and give enough space to ensure comfort for a user.



VERSO

VISITOR CHAIRS
> 255

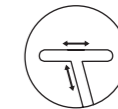
-  TILT MECHANISM
-  TENSION ADJUSTMENT
-  ADJUSTABLE ARMRESTS



209



VERSO

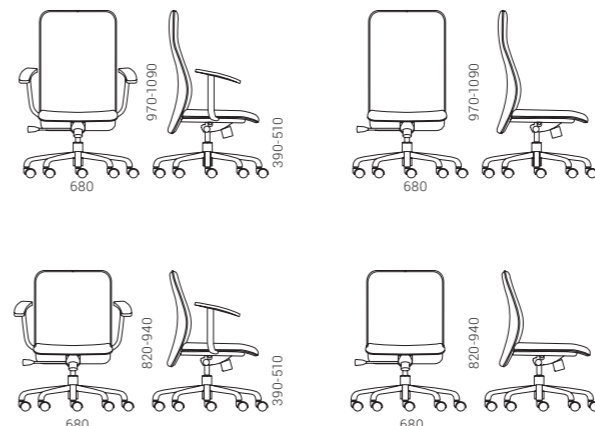

Your best office partner

The SWAY pivoting stool is a great choice for those looking for healthier sitting alternatives. It is a perfect active sitting solution for dynamic work and cooperation areas. The upper part of the stool swings and moves together with its user, so it can also be used as a support when standing. This allows you to change the position of the body at the workplace throughout the day without distracting from important tasks. Due to its modern and sleek design, this balance chair will fit into any contemporary office space.

210



Unique pivoting system

The distinctive feature of this chair is its unique pivoting system, hidden inside an elegant black plastic base. With the help of this system, the seat can be tilted up to 8 degrees in all directions and rotated 360 degree.

Easily adjusted and safe

A pneumatic lift mechanism lets you fine-tune the perfect level for different work surface heights. Adjustable seat height range from 600 mm to 850 mm, so you can smoothly adjust from sit to stand position in seconds by using an elegant brown leather strap. Having a non-skid surface, the base of the stool will always remain stable, while the high-quality materials will ensure safe and long-lasting use.



211

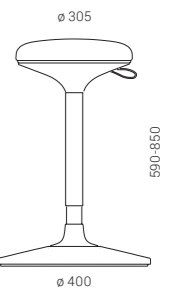

Significant functionality

The SWAY pivoting stool can be easily fit with to height-adjustable desks, as well as high, or conference tables. Due to its compact size, this chair is also perfect for different size SILENT ROOM acoustic rooms or small meeting rooms. The seat of the stool is made of polyurethane and can be upholstered in a wide selection of fabric, genuine leather, and leather look.

212

SYNERGY
S68



213

ERA
009

SYNERGY
S68



Design by Baldanzi & Novelli designers

TASK CHAIRS > 186
VISITOR CHAIRS > 228

Dynamic and flexible work setting

The standards of ergonomic in modern office spaces are constantly changing, just as our understanding as to what work environment is best for the performance and well-being of office workers. One thing is clear: it is important to change one's body posture throughout the day and avoid staying in the same position for extended periods of time. WIND high task chair is great because it can be easily adapted to a variety of work settings, whether it is a sit-stand desk, a high desk or reception furniture.

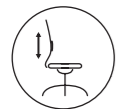

ADJUSTABLE LUMBAR SUPPORT

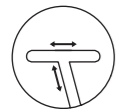

ADJUSTABLE ARMRESTS

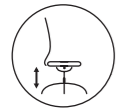

PNEUMATIC HEIGHT REGULATION

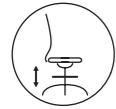

FOOTRING HEIGHT ADJUSTMENT

214

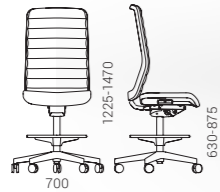
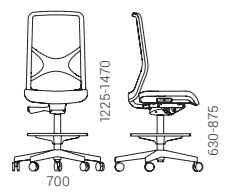
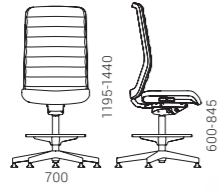
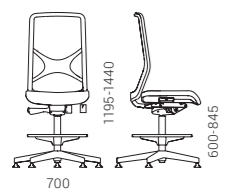

HIGH SWIVEL CHAIRS

Keeping you comfortable and safe

With their soft, comfortably shaped seat and ergonomically designed mesh backrest, WIND chairs are comfortable to sit on even for long periods of time. Ring-shaped adjustable-height leg rest allows you to adjust the chair to your height, maintain a correct seating position and avoid unpleasant back and neck pain. The castors will provide extra safety and stability as they will be locked in place while you sit.

216

-  PNEUMATIC HEIGHT REGULATION
-  FOOTRING HEIGHT ADJUSTMENT

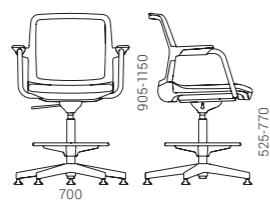
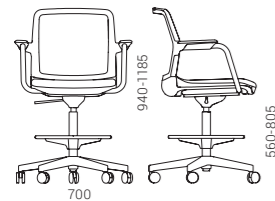

WIND

HIGH SWIVEL CHAIRS



WIND

EXECUTIVE
CHAIRS

NORTH CAPE

Design by Baldanzi & Novelli designers

TASK
CHAIRS
> 194

VISITOR
CHAIRS
> 236

In harmony with modern
elegance and comfort

Creating the manager's office using these chairs, you will
ensure not only a stylish workplace but also comfort.



reddot winner 2021
office design

218

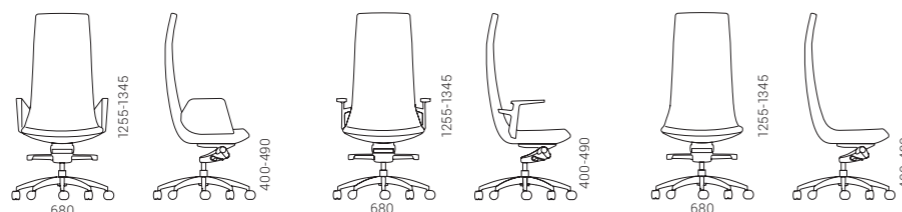

NORTH CAPE

EXECUTIVE
CHAIRS



NORTH CAPE



KNEE-TILT
MECHANISM



TENSION
ADJUSTMENT



LOCKING
POSITIONS

Create different images

In order to accomplish desired style for the executive office, you can choose from 2 models: laconic, simple but elegant design or much more sophisticated silhouette with a bigger backrest, softer seating pad and unique pattern of horizontal stitching lines.

220

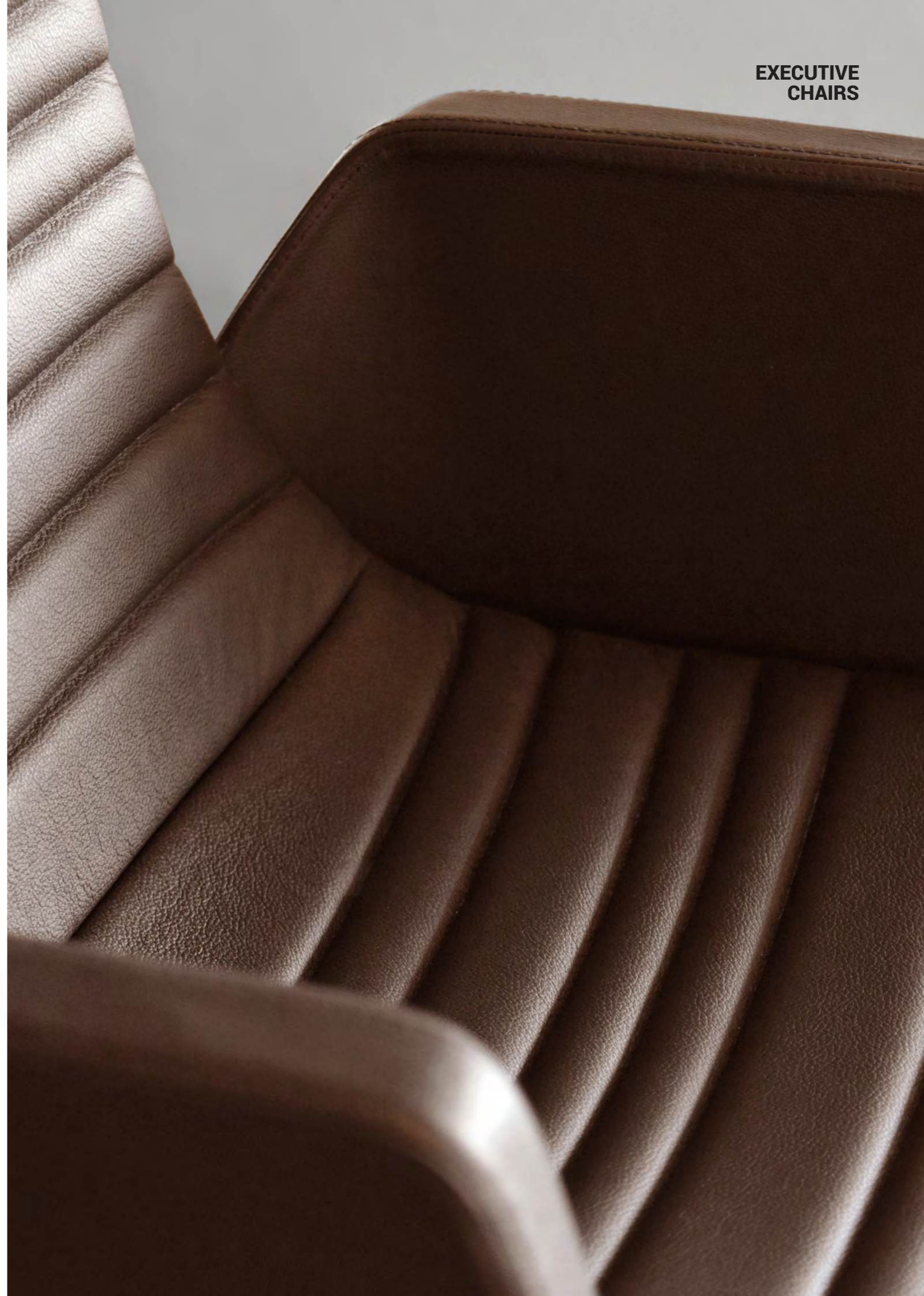
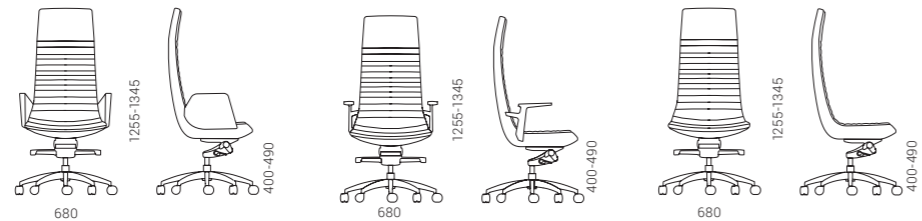

EXECUTIVE
CHAIRS



NORTH CAPE

NORTH CAPE

Good aura at work is essential just like air

Aura chair harmoniously combines timeless, universal design and comfort, which is ensured by ergonomic functions of the chair and spacious seating part.

224

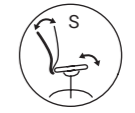
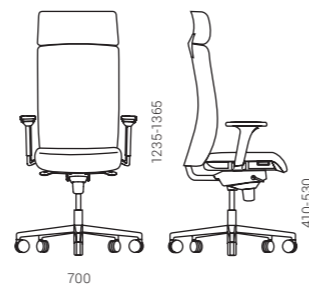

SYNCHRONOUS
MECHANISM



TENSION
ADJUSTMENT



SLIDE SEAT



LOCKING
POSITIONS



HEADREST

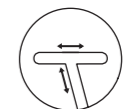

ADJUSTABLE
ARMRESTS

225



Universal task chair for executives

EVA.II's impetuous modern design, wide range of functionality and universal features make it a great choice for work environments both in the office and at home. This chair can easily be adjusted to suit various different needs.

226



Comfortable back and head rests

The backrest with a light, porous polyester mesh moulds itself to the curvature of the user's back, ensuring comfort and constant airflow, while a firmer plastic mesh grants additional support. The executive chair variant also has a soft polyurethane headrest, which helps reduce neck muscle tension during long work hours.

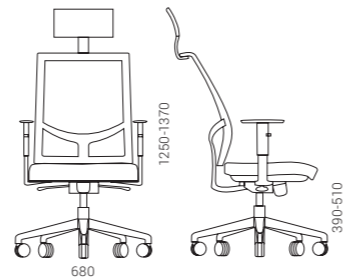

Different variations and images

Design EVA.II according to your own preference by choosing between the various frame, mesh and seat colour, as well as base options.



SYNCHRONOUS
MECHANISM



TENSION
ADJUSTMENT



LOCKING
POSITIONS

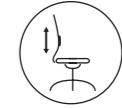

ADJUSTABLE
LUMBAR SUPPORT



HEADREST

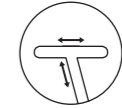

ADJUSTABLE
ARMRESTS

227



WIND

Design by Baldanzi & Novelli designers

TASK
CHAIRS
> 186

HIGH
SWIVEL
CHAIRS
> 214

Continuous yet distinctive design

One of the main features is its uniform design including the structure of the back and armrests as well as the upholstered seat.

Blends in any office
environment



4-legs

4-star

Cantilever

5-star

228



WIND

229



STACKABLE

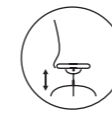

PNEUMATIC HEIGHT
REGULATION

WIND visitor chairs are extremely versatile and perfectly suited for meeting, conference or reception areas. These chairs come in four different base options which can be easily adapted to a variety of office settings.

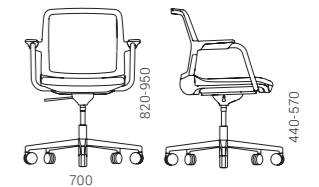
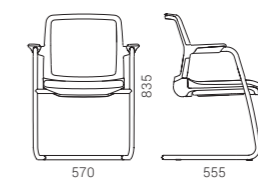
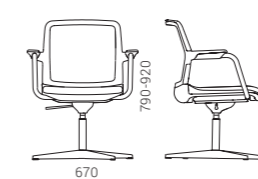
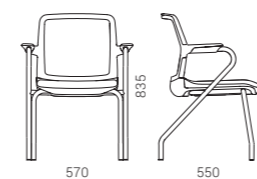

WIND

VISITOR
CHAIRS

VISITOR
CHAIRS



WIND

WIND

TWIST&SIT

Design by Christina Strand and Niels Hvass

“

Elegant and divided back enlarges the comfort of the chairs and at the same time the chair has a strong iconic expression.”

Christina Strand and Niels Hvass

HIGH
CHAIRS

> 256

LOUNGE
& SOFT
FURNITURE

> 266

> 270

> 274

> 278

Distinctive character and freedom of expression for your style



232



233



STACKABLE

These chairs can be adapted based on the desired interior style as you can choose between industrial style metal legs and Scandinavian style wooden legs. The curved shell and ergonomic seating position makes collaboration process even more comfortable.

The TWIST&SIT chair can be used on its own or in large groups that look great in any space either it's a reception, conference hall or a meeting room.

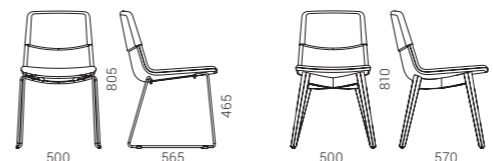

VISITOR
CHAIRS

VISITOR
CHAIRS



SYNERGY
S62

SYNERGY
S69

VELITO
GT9



TWIST&SIT

TWIST&SIT

NORTH CAPE

Design by Baldanzi & Novelli designers

TASK CHAIRS > 194
EXECUTIVE CHAIRS > 218

NORTH CAPE chairs are refined and stylish, thus can perfectly represent company in meeting and guest areas.



236

2 sizes for different needs

Chairs with lower backrests do not have armrests and are perfect for sitting comfortably in waiting or smaller meetings areas. Conference chairs with the same seating part proportions and armrests like those of task chairs are suitable for more spacious meetings rooms, where longer, more important and likely representative meetings take place.



A choice from 3 bases



237

There are three options for NORTH CAPE visitor chair base, which suit different needs and office areas. Swivel, 4-leg base in polished aluminium provides elegance and sophistication. Chairs with cantilever base or 4-leg base are convenient for smaller, cosier meeting areas.

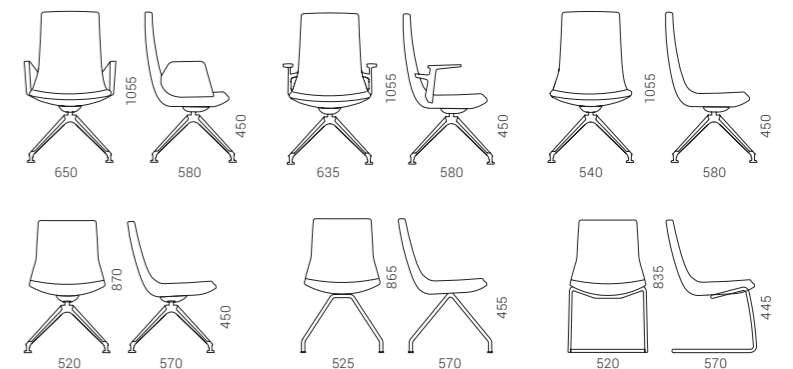

VISITOR
CHAIRS

VISITOR
CHAIRS



NORTH CAPE

NORTH CAPE

Conference chairs with a light, minimalist silhouette

Participants in every conference

Because of their simple construction, MOON visitor chairs are very convenient for conference and training rooms. It is easy to arrange them in orderly rows by using connectors.

240



241



Being compact and easily stackable (up to 5 chairs), they save your storage space and are convenient for transportation. Also, for user's convenience, it is possible to add a rotatable writing tablet, which can be fixed to a chair with armrests.

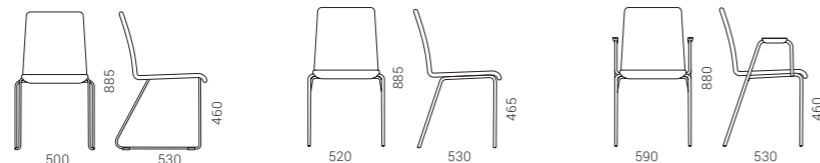

VISITOR CHAIRS

Bases of two types

There are two different steel bases available for MOON conference chairs: traditional 4-leg or elegant sled frame which is made of very thin and elegant lines. The sled base has plastic glides which help to move the chair very easily without any damage to the floor.



STACKABLE



WRITING TABLE



CONNECTORS

242



MOON



MOON

MOON Wood

HIGH
CHAIRS

> 258



STACKABLE



WRITING TABLE



CONNECTORS

Work breaks
without any
worries

Monobloc unit of the backrest and the seating part is made of plywood. Because of high quality materials, MOON Wood visitor chairs are perfect for office areas in which employees take some rest, eat or simply have a coffee break. Don't worry if your chairs get dirty, as the surface can be cleaned easily.

244

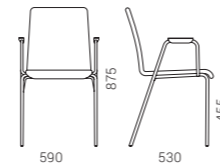
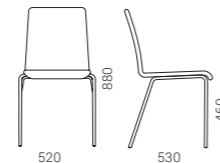
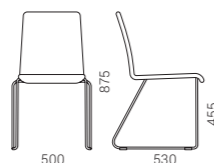

Playfulness in
the office

They are modern, practical, and light, but at the same time durable, so they are perfect for conference and training halls, office spaces where visitors are received or where you can eat and relax.

246



Choose from a range of different colors of plastic and tapestries and you will definitely fulfill any interior.



247



STACKABLE



WRITING TABLE



CONNECTORS

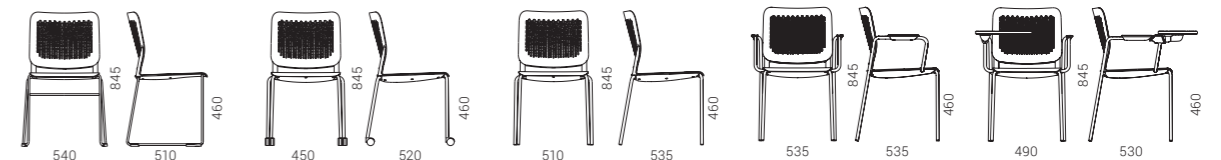
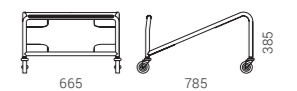

GAMA

Any place, any time

It was created for those who appreciate comfort, easy-to-adapt style, and functionality.



248

Different features
for different needs



STACKABLE

There are three different steel bases available for GAMA chair system: a traditional 4-leg base, a cantilever frame base, and a 4-leg base with castors for an easier movement in spaces. All bases can be either chromed or powder-coated (metallic or black).

The backrest of the chair can be upholstered with either fabric or mesh.

Being stackable, (up to 6 chairs) these chairs are easy to transport and can optimize the room space.

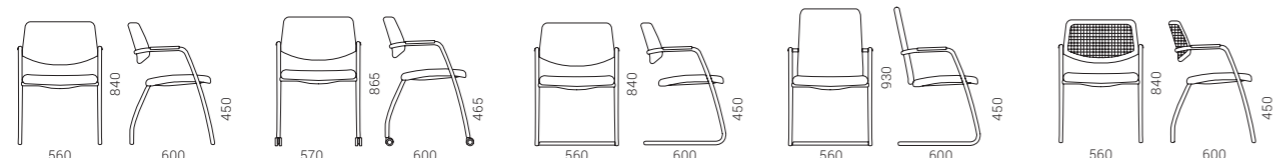

GAMA

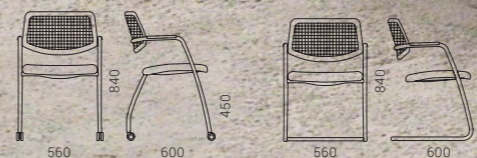

GAMA

Light and graceful
silhouette visitor chair

For convenient
meetings

250 The back of the visitor's chair can be combined with a lightweight and breathable polyester mesh that provides comfortable support and constant air circulation, or with a stiffer plastic mesh that provides greater support for the back.

Chrome-plated flexible steel frame legs ensure comfortable seating during long and intense meetings. During the moment of relaxation, you can easily swing in the chair.



Compactness

You can easily stack EVA visitor chairs on top of each other (up to 3 pcs.).



STACKABLE

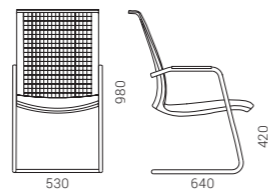
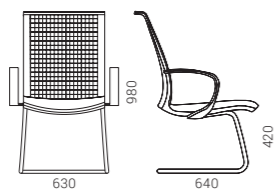
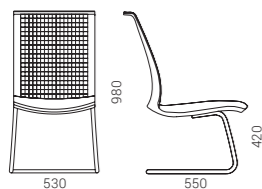



Thin line,
delicate and
modern design

252

The chair is available with either black polyamide or polished aluminum base with castors. Thanks to its simple and intuitive design, DIVA can be easily adapted to individual user needs.



TILT
MECHANISM



TENSION
ADJUSTMENT

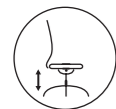

PNEUMATIC HEIGHT
REGULATION

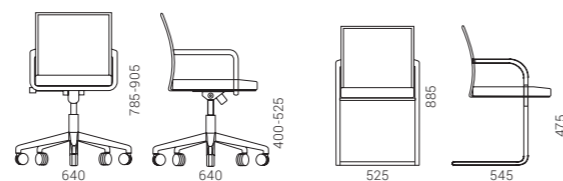

AURA

TASK
CHAIRS
> 208

EXECUTIVE
CHAIRS
> 224



STACKABLE

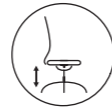

PNEUMATIC HEIGHT
REGULATION

254

Easily adaptable design

Wide variety of fabric and leather colours allows you to choose a character for your chair - from modest, easily adaptable to different office interiors, to exclusive, attracting attention.

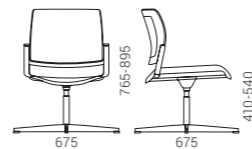
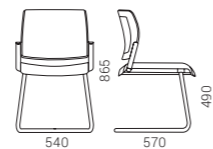
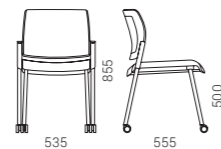
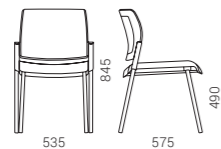

VERSO

TASK
CHAIRS
> 209



255

4 base types

Depending on your circumstances, you can choose between four different bases. All of them are chromed, making it easy to match them to various fabric types and colours.

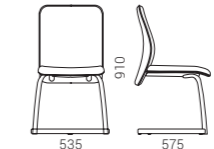
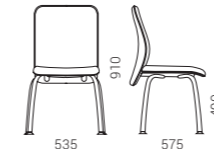
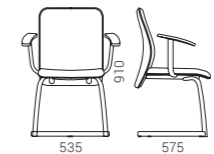
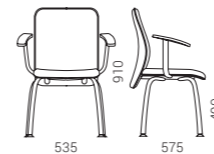

HIGH
CHAIRS

TWIST&SIT

Design by Christina Strand and Niels Hvass

VISITOR
CHAIRS

> 232

LOUNGE
& SOFT
FURNITURE

> 266

> 270

> 274

> 278

256



These Scandinavian design chairs are a perfect fit for high tables in the lounge, cafeteria, or collaboration areas. With their appealing look, they will get employees together for lunch, coffee break, or for an informal meeting. The ergonomically shaped curves in both the seat and backrest give users extra comfort. You can select different colour combinations for the upholstered part of the chair and choose either metal or wooden legs. Contrasting colours will bring a sense of exclusivity to your TWIST&SIT furniture.

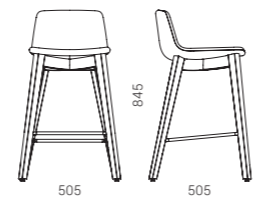
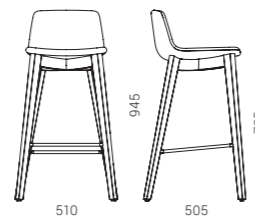
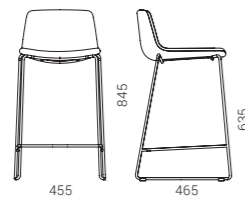
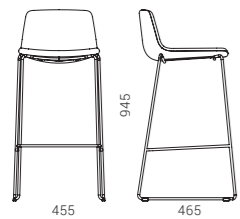

TWIST&SIT

HIGH
CHAIRS



TWIST&SIT

HIGH
CHAIRS

MOON

TASK
CHAIRS
> 204

VISITOR
CHAIRS
> 240



MOON high chairs are a versatile option as they can be used for multiple purposes: in relaxation or dining areas as well as for short meetings.

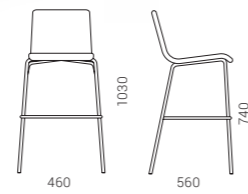

HIGH
CHAIRS



258

MOON Wood

VISITOR
CHAIRS
> 244

If you are inspired by nature, you can choose plywood chairs covered with beech or oak veneer. If you prefer minimalist style, black stained beech veneer or white laminate will be an ideal choice for you.



STACKABLE

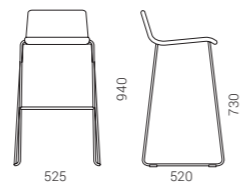

Playful yet practical

Wait chairs are modern, practical and light, but at the same time durable. The delicately perforated back ensures air circulation. The chairs playfully combine two materials - plastic and fabric. You can choose from two models: a model where both the backrest and the seat are made of plastic and one that combines a perforated plastic backrest and a seat covered with a tapestry or leather look for a more comfortable seating.

260



261

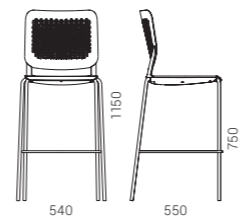

LOUNGE & SOFT FURNITURE

SOFAS

262



TWIST&SIT Soft

> 266



ARCIPELAGO

> 288



CUMULUS

> 299

LOUNGE CHAIRS



SOFT ROCK

> 282



ARCIPELAGO

> 288



TWIST&SIT Soft

> 270



VEGAS

> 298



TWIST&SIT

> 274



CUMULUS

> 299

263

ARMCHAIRS



TWIST&SIT
> 278



MEG
> 304



TULA
> 300



LUNA
> 305



DANAE
> 302



NORTH CAPE
> 236

MODULAR SYSTEMS



SOFT ROCK
> 282



ARCIPELAGO
> 288



JAZZ Chill Out
> 294



CUMULUS
> 299

POUFS



GIRO
> 296



JAZZ Chill Out
> 294



ARCIPELAGO
> 288

TWIST&SIT

Soft

Design by Christina Strand and Niels Hvass

VISITOR
CHAIRS

> 232

HIGH
CHAIRS

> 256

LOUNGE
& SOFT
FURNITURE

> 270

> 274

> 278



266

An ultimate sense
of comfort

TWIST&SIT Soft seaters ensure a comfortable sitting experience thanks to the increased thickness of the polyurethane padding. The recessed lower part of the backrest subtly conforms to the natural contours of the spine, making the user feel comfortable.

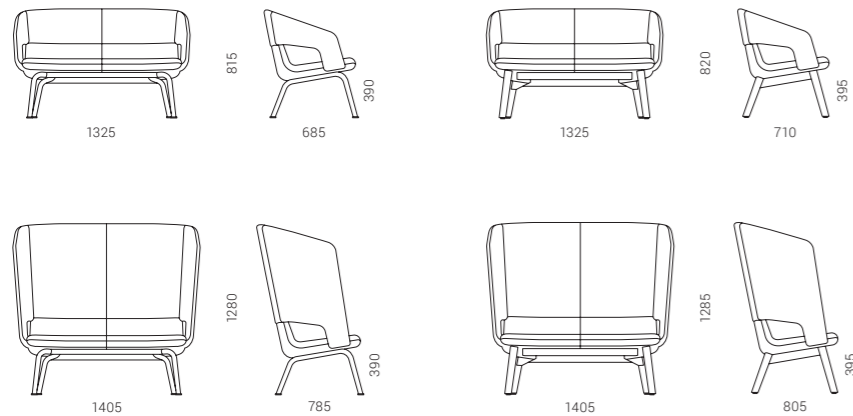

TWIST&SIT Soft

Meets
the diverse
needs of
employees

Low-back armchairs and sofas are ideal for office reception areas or open-plan relaxation spaces, lounge zones or cafés. High-back seaters are a convenient solution for employees who need a private space for themselves where they can escape from the noisy office environment and relax or focus on individual tasks.



267

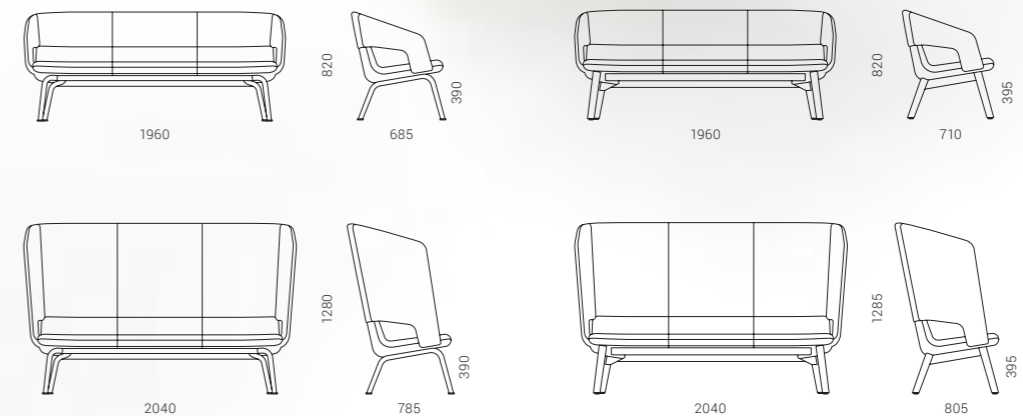

TWIST&SIT Soft

SYNERGY
S85

SYNERGY
S53

SYNERGY
S27

SYNERGY
S55

SYNERGY
S08

SYNERGY
S45

TWIST&SIT

Soft

Design by Christina Strand and Niels Hvass

VISITOR
CHAIRS

> 232

HIGH
CHAIRS

> 256

LOUNGE
& SOFT
FURNITURE

> 266

> 274

> 278

Exceptional
design
rhythms

270



271



An invitation to pause

TWIST&SIT Soft lounge furniture with its expressive design is an invitation to pause and to take a break from the hectic pace of the day.

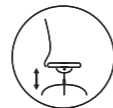

PNEUMATIC HEIGHT
REGULATION

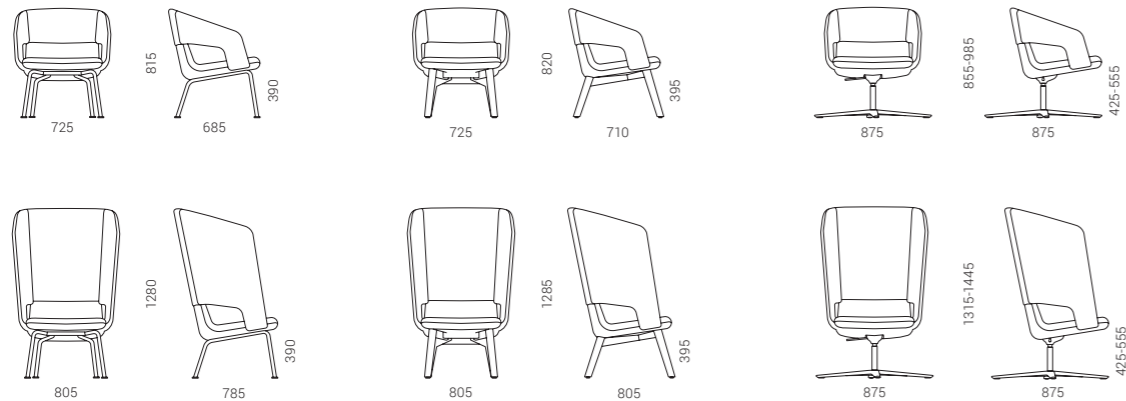

Well-rounded shapes and a distinctive connection between the lower and upper parts of the backrest create an instantly recognisable look.

LOUNGE
& SOFT
FURNITURE



SYNERGY
S53

RNN
D17

TWIST&SIT

Design by Christina Strand and Niels Hvass

VISITOR
CHAIRS

> 232

HIGH
CHAIRS

> 256

LOUNGE
& SOFT
FURNITURE

> 266

> 270

> 278

274



reddot award 2019
winner

An exclusive design of TWIST&SIT chair will be a spotlight of any office. It has a well-rounded high backrest shelter which isolates the users from surrounding noise, giving them a sense of comfort, protection, and minimizing distractions. The seat of the TWIST&SIT is wider than a typical size seat, thus it allows you to relax and enjoy an ultimate sense of comfort. The chair will add a special touch to both formal and informal meeting spaces or relaxation areas.



**LOUNGE
& SOFT
FURNITURE**

Distinctive
character and
freedom of
expression for
your style

You can select different colour combinations for the upholstered part of the chair. Contrasting colours will bring a sense of exclusivity to your TWIST&SIT furniture. It also comes in a variety of different base options so there is no need to compromise on style. When choosing the right one, consider your functional needs as well as the fabric or design to accommodate your preferences.

276

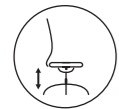

PNEUMATIC HEIGHT
REGULATION

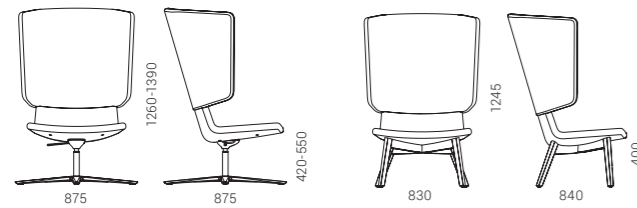

TWIST&SIT



TWIST&SIT

Design by Christina Strand and Niels Hvass

VISITOR
CHAIRS

> 232

HIGH
CHAIRS

> 256

LOUNGE
& SOFT
FURNITURE

> 266

> 270

> 274



278

TWIST&SIT furniture stands out for its minimalist and clean refined lines as well as strong visual identity. The rounded edges and smooth transitions between the backrest and the armrests offer a comfortable seating position even if the work meeting lasts longer than expected.

TWIST&SIT chairs with metal bases have a more modern look, whereas the wooden ones give the office a more homely feel and at the same time add more elegance to the room. Both base options are available in dark and light colours to further add to the beauty of contrast.

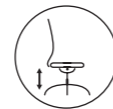

PNEUMATIC HEIGHT
REGULATION

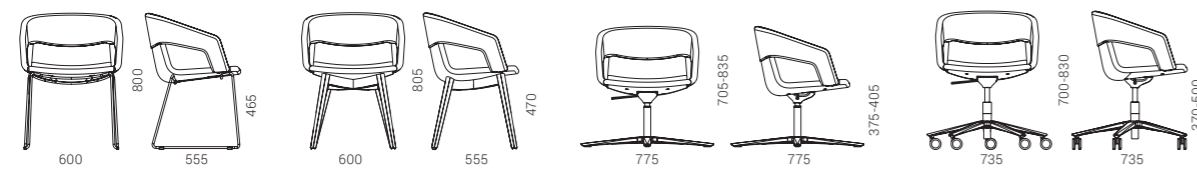

With its visually striking Scandinavian design, this soft seating family is perfect for modern offices that exude a chic vibe and looks just as nicely in traditional office spaces. TWIST&SIT collection offers a perfect combination of expressiveness, improvisational freedom and a variety of styles.

LOUNGE
& SOFT
FURNITURE



SOFT ROCK

Design by Christina Strand and Niels Hvass

Inspired by the new generation

Being open to new things, a sense of freedom, and the ability to adapt quickly to changing situations were the source of inspiration behind SOFT ROCK lounge seating collection.

282

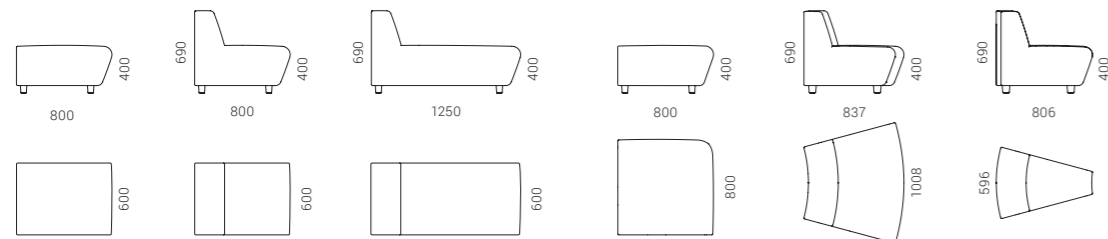
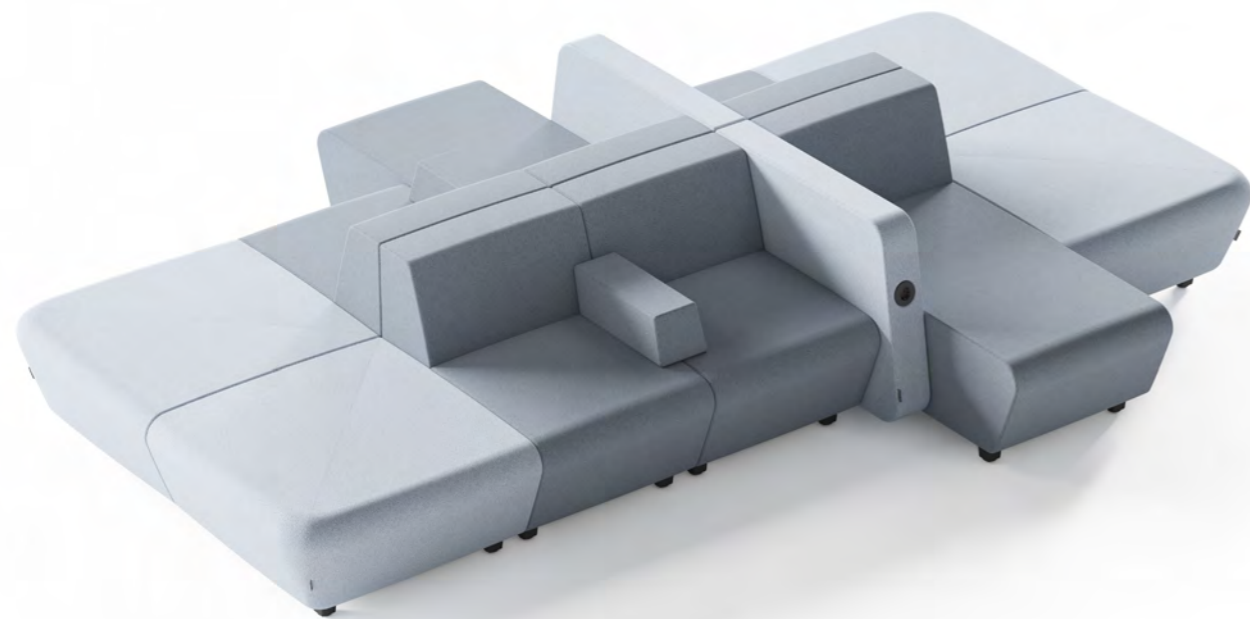

SOFT ROCK

Flexible modular system

Unleash your creativity and set up desired combinations by selecting from six main lounge seaters available in different sizes and forms, which can be easily combined or rearranged to make efficient use of the space. Depending on your actual needs, use additional accessories – armrests and screens to make the most of your lounge seater composition.

283



Privacy and safety

It is a perfect tool allowing you to create a more private area for individual work that requires concentration within an open space. Also, thanks to the screens, you can create a safe atmosphere by ensuring desired distances between people without totally isolating them.

284

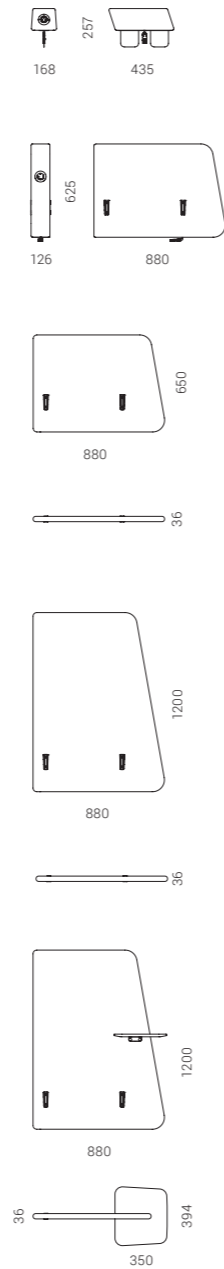

Always
"connected"



In order to meet your need for constant connectivity, the armrests of the SOFT ROCK furniture have in-built power sockets or fast charging USB (Type A+C) ports.



SYNERGY
S62

“

SOFT ROCK reflects a youthful and relaxed feel and offers numerous possibilities to set up and combine different spaces.”

Christina Strand and Niels Hvass

SOFT ROCK

SYNERGY
S63

Design by Baldanzi & Novelli designers

Release your creativity with ARCIPELAGO!

Arcipelago is a modular lounge seating system offering endless configuration possibilities. Choose your favourite configuration from our wide range of standard options or build your custom configurations by mixing and matching modular components. ARCIPELAGO modular configurable system is easy to assemble, disassemble, or reassemble.



288



ARCIPELAGO



Playful colours

289

Choose from our wide range of fabrics and colours or mix and match them to create a unique atmosphere for your office. The backrest and seat cushions can be easily removed and swapped.

ARCIPELAGO

**LOUNGE
& SOFT
FURNITURE**

3 heights

Thanks to their flexibility and 3 different height options, ARCIPELAGO lounge benches are a great choice for spaces of any size and style. The high-back option will provide you with more privacy and acoustic comfort.

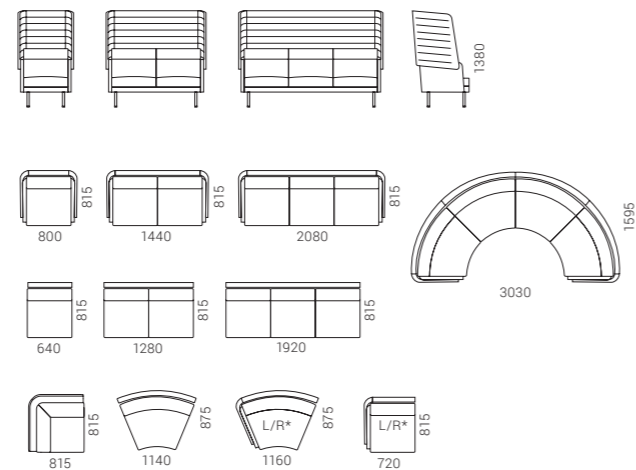
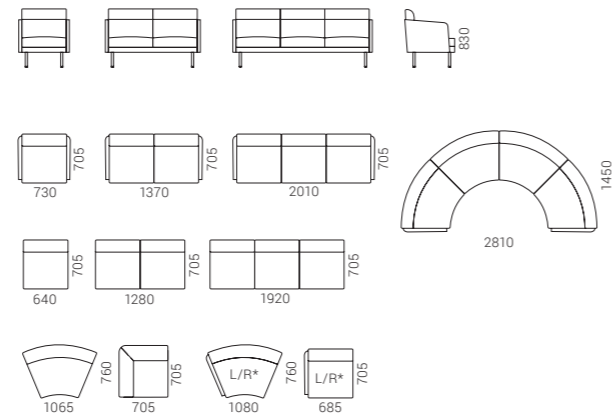
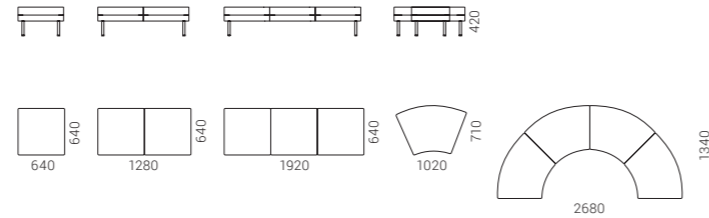

* - left/right

290

Useful accessories

Lounge benches come with well-designed accessories. You can choose a table or armrest with or without an integrated power socket or USB fast charger. Both of these can be easily mounted in between the seats.



**LOUNGE
& SOFT
FURNITURE**





JAZZ Chill Out

Design by Christina Strand and Niels Hvass

Freedom of improvisation

JAZZ Chill Out is an easily customizable pouf system for any lounge or waiting area in your office. A wide selection of fabric, artificial, and natural leather finishes opens up unlimited possibilities to create the desired interior atmosphere.

294



Convenient details for contemporary people

For the convenience of users, the poufs can have an integrated plug or USB fast charging socket - an extremely practical solution for not only office workers but for visitors as well. Another functional highlight of this system is the metal table, which can be easily placed on the surface of the pouf to protect objects from falling.

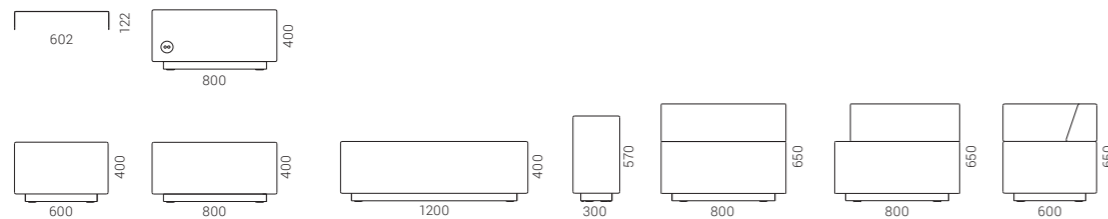

295

STEP Melange
L04

STEP Melange
L06

A true colour pallet
at your office

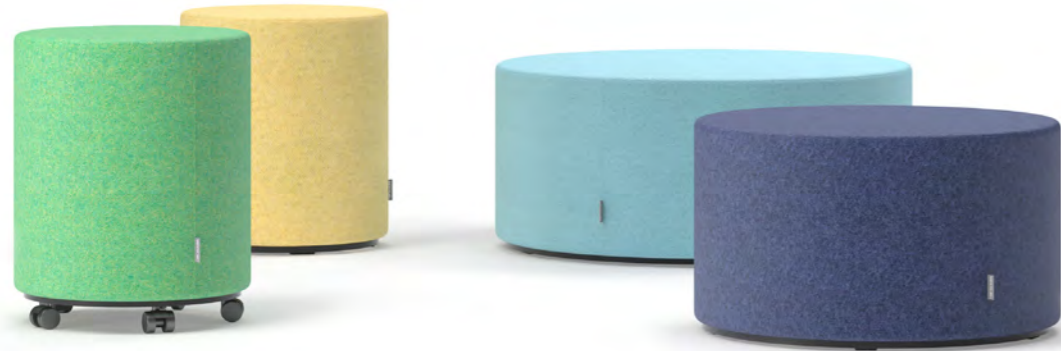

GIRO pouf system is a great way to liven up any office environment and create the desired mood by choosing matching or contrasting colours. A wide selection of fabric, leather look and genuine leather is available for this pouf system upholstery. Small, lightweight, and mobile GIRO can be effortlessly rearranged in space.

296

Customizable design

Variation of three different diameters and three different heights allows the user to choose the one that best suits their needs - it can be used both for sitting at a colleague's workplace or placed in the waiting and lounge areas. There are 2 base options available for GIRO system - with plastic glides or castors. Choosing plastic supports will create a more tidy office look while choosing castors will allow you to move the furniture around without much effort.

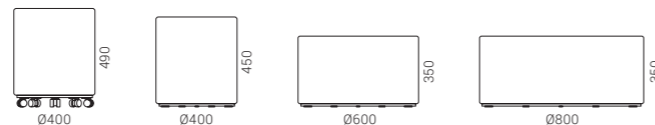

VEGAS

A temptation
to relax

A curved shape, lower and wider
seating area implies a welcoming
invitation to have a seat for
anyone passing by.

298



The chair shell can be upholstered with different
fabric combinations, leather look, or genuine leather.
Chromed steel sled frame base create a distinctive
character and provide durability while plastic glides
help prevent floor damage.

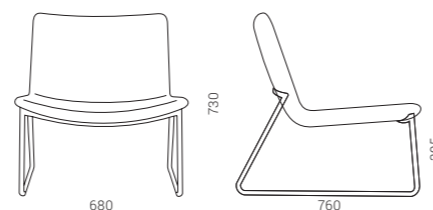

VEGAS

CUMULUS

Design by Kazuko Okamoto



299

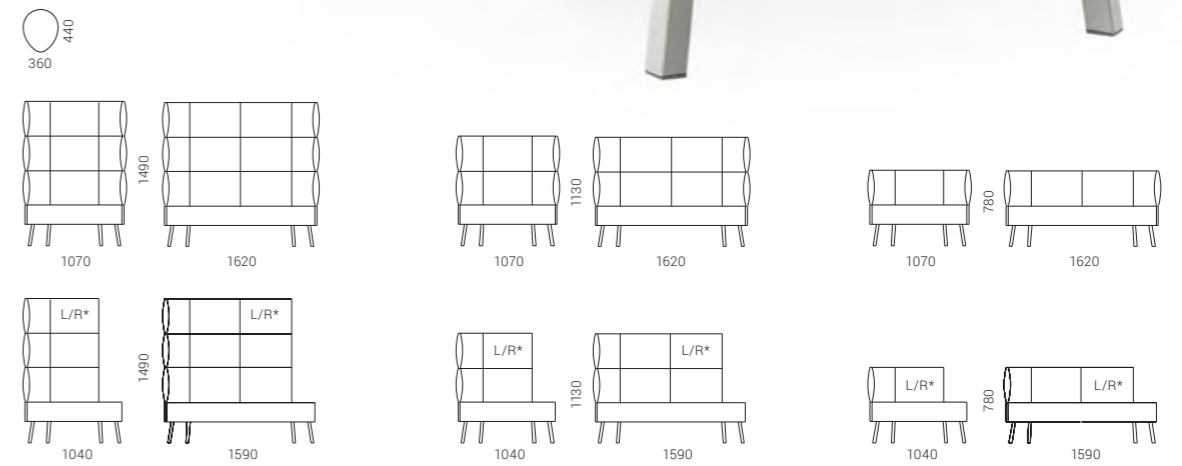

* - left/right



CUMULUS

Designed to bring comfort

It is a perfect fit for lounge and waiting areas or informal meeting spaces. The distinctive design of the chair is made to wrap itself around the user and provide not only a comfortable sitting experience but also coziness.

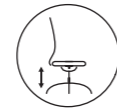

PNEUMATIC HEIGHT
REGULATION

300



Custom features for unique looks

TULA chairs are highly customizable as you can select individual colours for the front and back parts of the chair. You can even mix and match different materials for the separate parts of the upholstery. With our wide selection of fabric, leather look, genuine leather, the chairs can be adapted for a number of unique situations and looks.

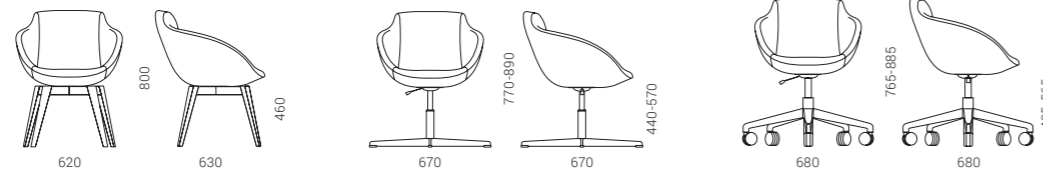

Make your office stand out

This chair is a perfect combination of elegance and comfort. A charming silhouette creates a sophisticated look and a welcoming feeling that is why this chair will perfectly blend in any conference room or waiting area.

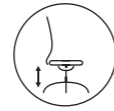

PNEUMATIC HEIGHT
REGULATION

302

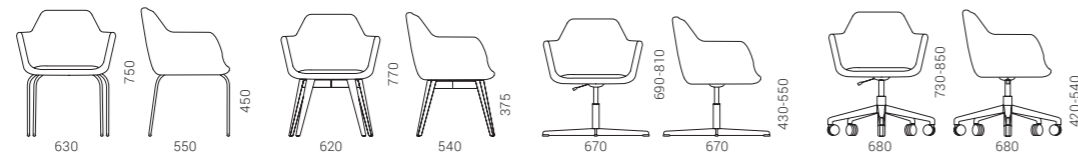

MEG

A distinctive addition
to your office

With its contemporary shape, MEG lounge chair will definitely find a place in any office space. A laconic design will suit those who appreciate a moderate style.

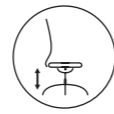

PNEUMATIC HEIGHT
REGULATION



304



MEG

LUNA

A proven design
that lasts

Stylish and refined, this lounge chair represents a classic approach to the office design. A simple yet timeless look makes LUNA a wise choice.

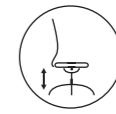

PNEUMATIC HEIGHT
REGULATION



305

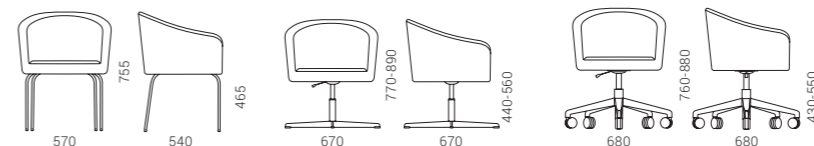

LUNA

EXECUTIVE FURNITURE



MOVE&LEAD

> 308



MOTION Executive

> 316



PLANA

> 322



AIR

> 326



NOVA Executive

> 330

MOVE&LEAD

Design by Gediminas Juška

“

Move! is a slogan of the modern man that represents the victory of mobility against stagnation, sloth and succumbing to negativity. A true modern leader is driven and open to innovation, a cosmopolitan dictating healthy lifestyle and a teacher who shapes his or her environment with dignity.”

Gediminas Juška



Your best move!

It combines the best in ergonomics and cutting-edge technology and is designed for modern active leaders. The desk's height can be adjusted between 740 mm and 1300 mm, this allows you to stay on the move and be active even at your desk.

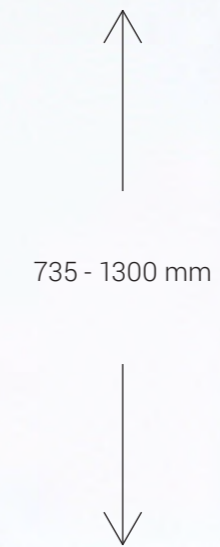

EXECUTIVE
FURNITURE

EXECUTIVE
FURNITURE

Every detail matters

MOVE&LEAD is a top-quality product which stands out for its uncompromising standards of excellence in craftsmanship. Curved wooden surfaces are shaped employing traditional manufacturing methods and following highest quality standards. Parts of different materials are joined together with every detail in mind.



MOVE&LEAD

Minimalism is
the new luxury

Clean, elegant lines, smooth transitions and subtle combinations of materials are guaranteed to make a strong visual impact in any office. HPL Fenix finish, natural oak, ash or walnut veneer and polished stainless steel surfaces form a harmonious whole and create a sense of subtle luxury.

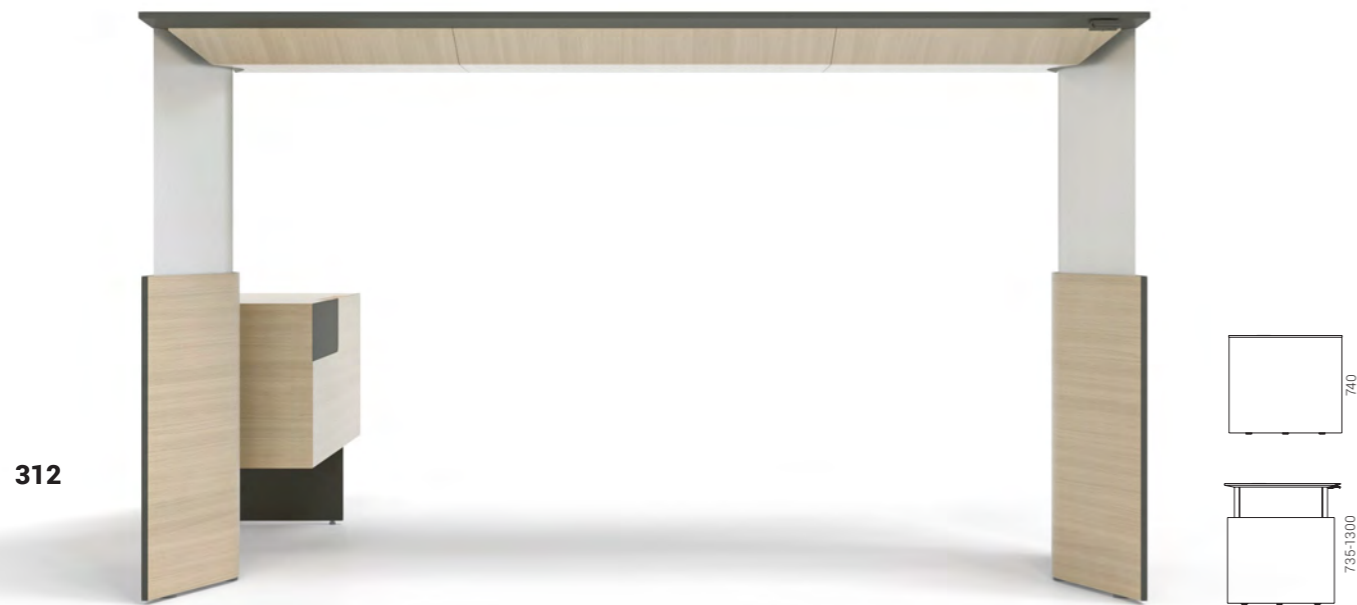

312

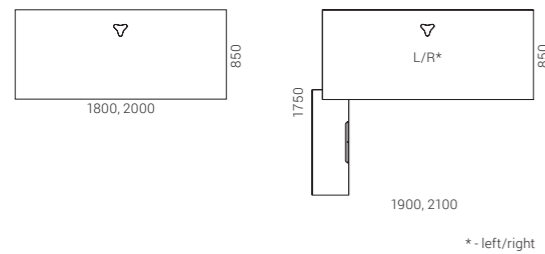

Declutter your workplace

The hidden wires can be accessed by opening an elegant minimalist lid. Wires and cables are routed through a subtle triangular-shaped hole with an original cover in a colour that matches that of the desktop or natural wood. MOVE&LEAD desk also has an in-built best-in-class Qi wireless charger (15W) for your smart devices.



MOVE&LEAD



Everything you need

Besides fixed-height or height-adjustable desks, MOVE&LEAD executive furniture system also includes storage solutions to keep your office essentials and personal belongings close at hand. The desk cabinet drawers with special inserts will ensure a well-organised workspace.

313

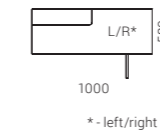

EXECUTIVE
FURNITURE



* - left/right



MOTION Executive

SIT-STAND
DESKS

> 26

Modern desk for
an active leader

MOTION Executive is a system of electric height adjustable desks, designed for a workplace of a dynamic leader. This desk is a combination of modern elegance and thoughtful functionality.

316



Modern sophistication

Panel legs hide the space under the desk giving more visual privacy. The feeling of elegance and sophistication is strengthened by the huge size of the top, which is designed for comfortable work. MOTION Executive can have even 36 colour combinations and allows you to create a desk which will suit your interior and personality best.

Easy to use

You can adjust the height of the desk by simply pressing the button or with a remote control application on your smart device. You can save the most comfortable positions and get a reminder to change your body position: to stand up or sit down.

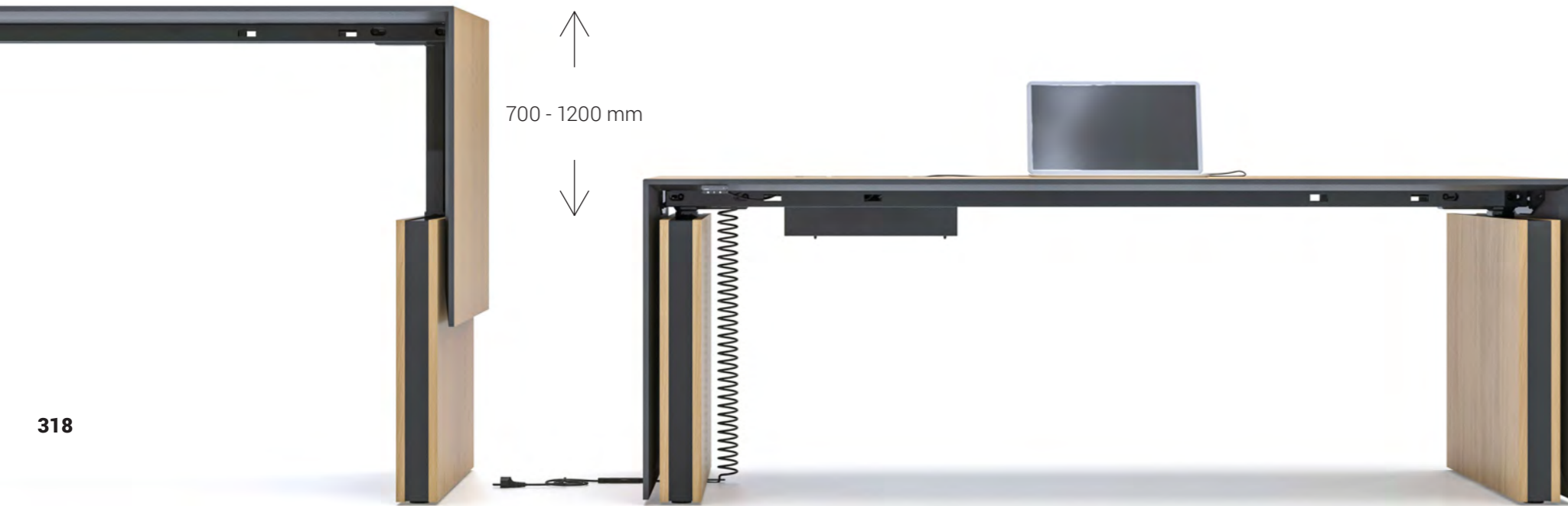

318

↑
700 - 1200 mm
↓

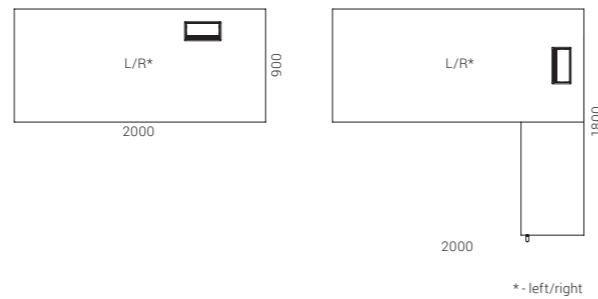

Reveal your style and individuality

According to your needs, you can choose from two MOTION Executive models: Executive desk made of veneer is designed for those who appreciate naturalness. The top has a subtly chamfered edge, while side panel wraps the desk and makes it look more united and modern. MOTION Executive desk with melamine finish does not have a side panel and looks more simple and modest.



Obstacle avoidance system

MOTION Executive desk is integrated with a sensitive gyroscope-based anti-collision unit that senses both hard and soft obstacles.

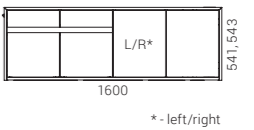

319

Functional storing

The range consists of several pedestals of different sizes and drawers with or without metal file bars. An easily reachable drawer can be situated in the upper corner of the desk, it is convenient for storing your valuables and can be locked for safety.





Design by Roberto Lucci and Paolo Pampanoni

A modern collection
of premium furniture



322

The Italian design of the tables is based on the harmony of straight and curved lines. The elegant three-part curved steel legs are crafted using advanced technology and are the ultimate distinctive feature of the system.

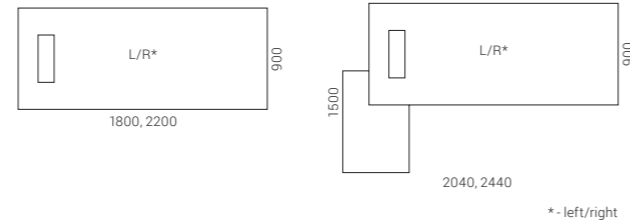

* - left/right

Wide range

PLANA tables come with an option of fixed or separate pedestals and many other different storage solutions, such as wardrobes or open shelf units. Modesty panels can be added for a higher sense of privacy, while a table extension can create a space to have meetings right at your desk.

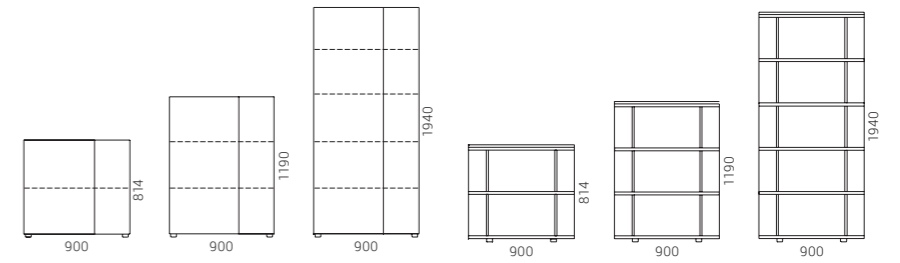
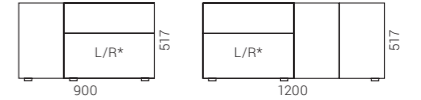

* - left/right

323

Quality in the details

The tables come with soft closing grommet, beautifully framed in metal and concealing the box for wire management. PLANA storage features subtle accents such as different panel thickness combinations, lowered top panel.



EXECUTIVE
FURNITURE

EXECUTIVE
FURNITURE



PLANA

PLANA

Two thicknesses

The tables are available in two different desktop thicknesses. The solid 120mm desktop gives the table an air of sophistication and will become the focal point of any office. The 25mm desktop is a universal choice for minimalistic offices, its pleasingly simple design will accentuate the unique structure of the legs.

326

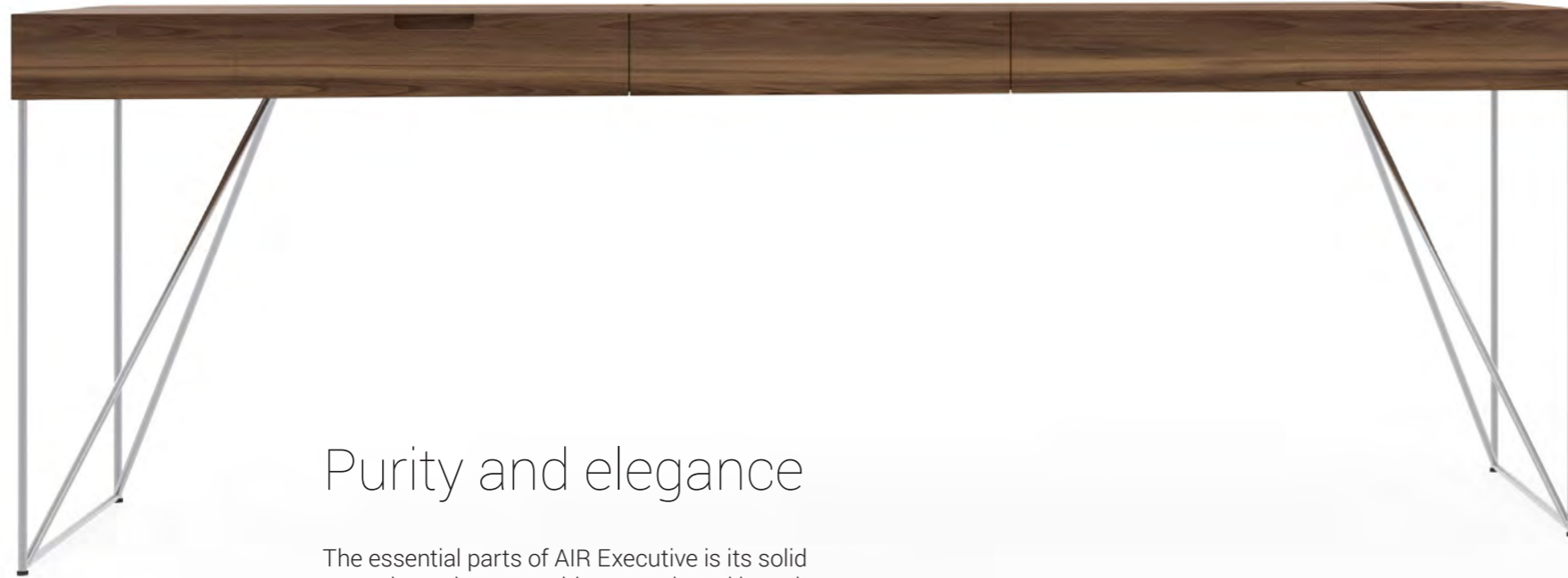

Purity and elegance

The essential parts of AIR Executive is its solid natural wood veneer table top and steel legs that ensure not only the elegant feel of the table, but also its stability. The integrated drawers are lined with high quality natural leather.

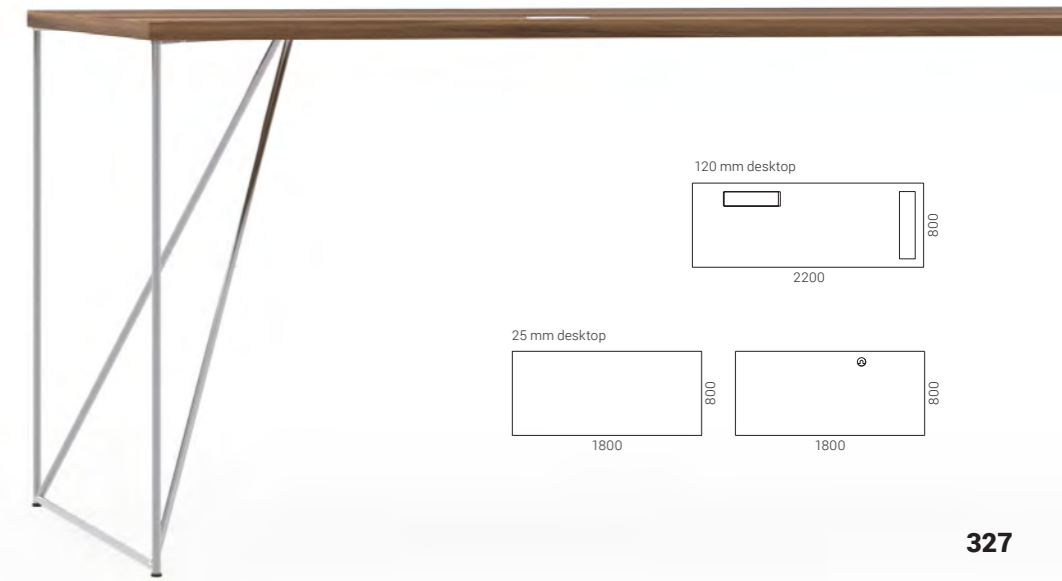

327

Hidden wiring

Steel table legs are designed in a way that hides all the cable wiring and allows you to keep all the unnecessary items out of your main workspace.



AIR

EXECUTIVE
FURNITURE

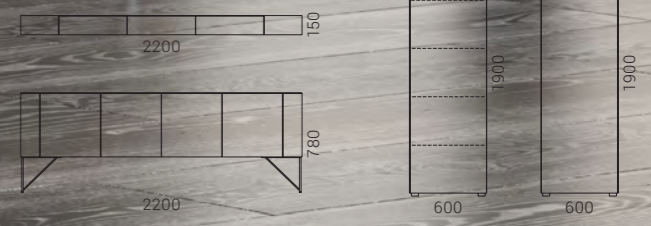

AIR

NOVA Executive

Versatile, intelligently designed solutions

NOVA Executive system's intelligently designed solutions allow you to create aesthetically pleasing yet very well-organized executive office space.

330



The Executive desks are available with two types of legs: regular U-shaped legs are a universal design solution that fits in any office while O-shaped legs are for those who want to add a modern touch to their space.

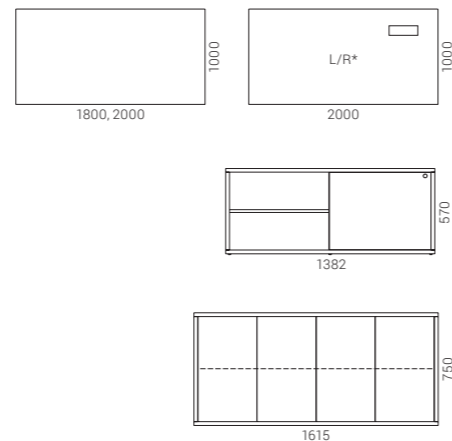
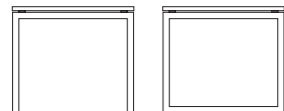

* - left/right

DESKS

> 54

CONFERENCE & MEETING TABLES

> 78

HIGH TABLES

> 92

OCCASIONAL TABLES

> 98



RECEPTION FURNITURE



ICE
> 334



DOMINO
> 340



NOVA
> 346



COSY
> 348



TERA
> 349

Minimalistic design

The strict lines of the ICE reception unit create an impeccable shape, suitable for both fancy and ascetic office interiors.

334



Subtle combinations

Depending on your vision for the interior, choose between a cozy melamine, or a luxurious veneer finish. Various front and top combinations are also available. Using the same finish on the top, base and front will create a solid and minimalistic reception unit, which will be as clean and smooth as ice. On the other hand, introducing a different-coloured top or decorative inserts will allow you to subtly reveal the elegance of this reception unit.

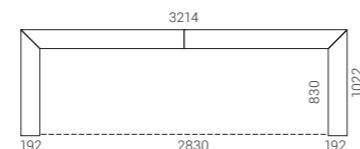
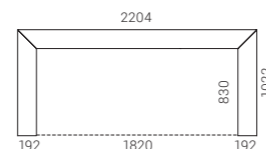

Ergonomic workspace

The ICE reception unit conforms to the needs of an ergonomic workspace and fits either one or two workstations – a perfect match for NARBUTAS sit-stand or fixed-height desks.

336



337



RECEPTION
FURNITURE

RECEPTION
FURNITURE



ICE

ICE

The rules are simple:
never stop creating!

DOMINO is a unique piece of furniture that will enable you to create a one of a kind design for your reception in just 4 simple steps. There are no two identical rounds in the game of dominoes, just like there are no two identical DOMINO pieces of furniture!

Easy way to create
unique reception
furniture

Firstly, choose the furniture base that suits you best from a range of nine different options. Secondly, combine two thicknesses of exterior panels (18 and 31 mm). Thirdly, choose panels in multiple colours and combine different coatings: upholstery, melamine and natural veneer. Lastly, create your own custom pattern using panels available in 200, 400, 600 and 800 mm sizes.

340

341

Cosy atmosphere and acoustic comfort

For your DOMINO setup, we recommend using MODUS acoustic screens which will allow you to maintain consistency in your interior style and provide employees with a sense of privacy.

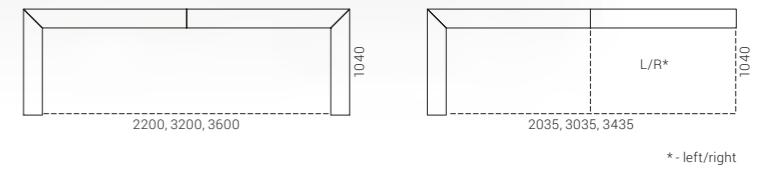
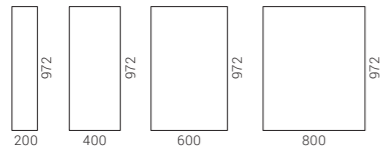
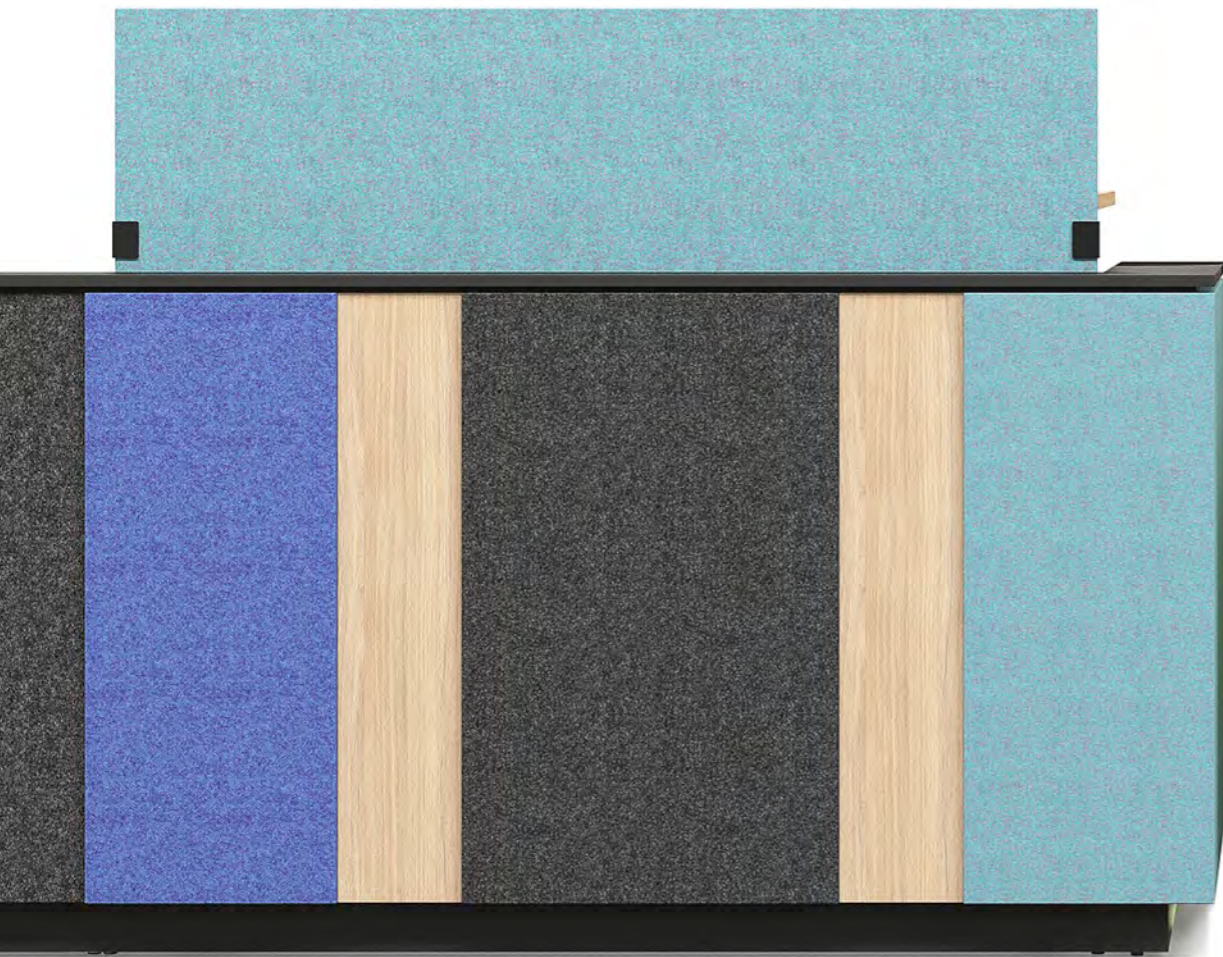

Ergonomic workplace

You can create an ergonomic workplace using both regular or sit-stand desks which can be adjusted to a chosen height by employees.

Cable management solutions

DOMINO reception furniture has all the cable management solutions that are necessary for an ergonomic workplace. Electrical and internet cables will not get in your way and your desk area will be clutter-free and aesthetically pleasing to the eye.







346

Varying forms

Our reception furniture sections are available in different forms. Choose a combination best suited for your office layout.

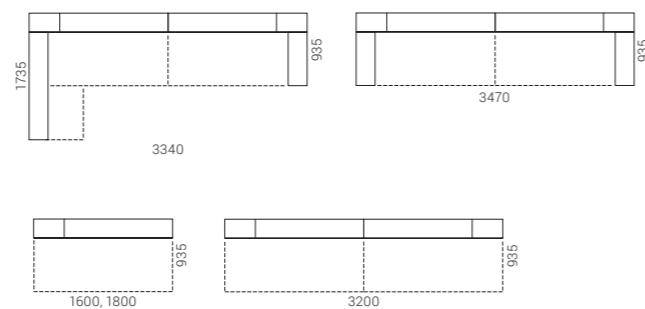

Decorative elements

NOVA reception furniture features nice acrylic glass inserts which add a playful touch to these pieces of furniture.

COSY



348

A clean, modern look with no sharp corners on the front side will create a friendly and cosy atmosphere for your visitors. A compact-looking reception is equipped with a 2000mm long table which provides plenty of working space and has many niches for storage. This product also features high-quality impact-resistant materials for better durability.



TERA

This modular reception furniture system offers modules in different forms and sizes and is ideal for reception areas of various offices.

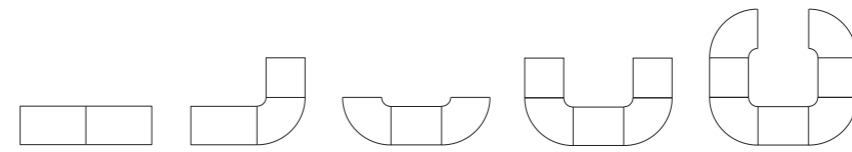

349

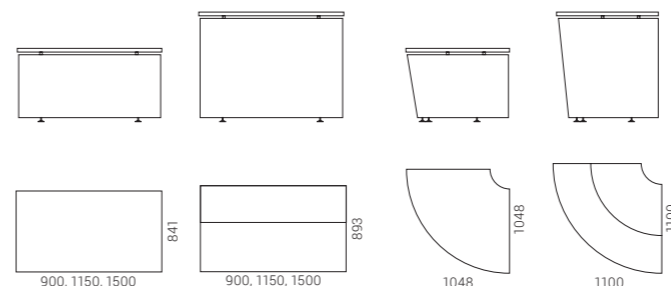

CUSTOM-MADE SOLUTIONS

EXPLORE OUR
IDEAS FOR YOUR
PERSONALIZED
OFFICE SOLUTIONS

350



Functional
office niches

> 352



Welcome area
personalization

> 356

351



Office zoning
solution

> 358

Functional office niches

We invite you to look at the office niches with a creative perspective, use integrated furniture and make them functional.

352



The remote areas of corridors could be a great place for convenient and safe storing of the personal yet less frequently used belongings, also office supplies. Storage facade doors with openwork metal look subtle and light. There is a wide range of available combinations.



PET felt panels with great acoustic features not only absorb the noise but also can be produced in a variety of different shapes and colours, therefore they can definitely create an image adapted to a specific office interior.





Lounge area with the available coffee point right next to the usual workplace encourages natural collaboration between colleagues. Also, short breaks increase productivity.



Storage unit with integrated coffee, tea or even ice-cream machine is comfortable to use and looks neat.

Welcome area personalization

The welcome area requires a lot of customized solutions to form a unique brand image of the company. We can create a reception with compact HPL, metal openwork or even PET felt details upon your request.

356



Office zoning solutions

We believe that office accessories should be functional. Plants are often used in modern interiors to create a pleasant atmosphere, clean environment for employees, but at the same time, greenery becomes a stylish office accent. Plant boxes with metal construction is a visually attractive practical solution for dividing the open space. Metal loft-style shelves and partitions is also a great solution to keep plants, books, and with added writing or magnetic boards can become a very useful tool for team meetings.

358



MATERIALS

SURFACE
MATERIALS

> 362

UPHOLSTERY
MATERIALS

> 363

360



361

SURFACE MATERIALS

Melamine

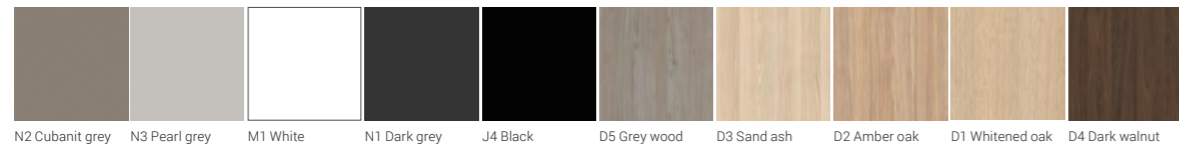

HPL

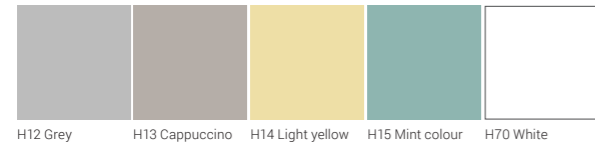

HPL Fenix

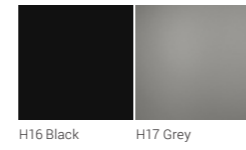

Solid wood



Veneer

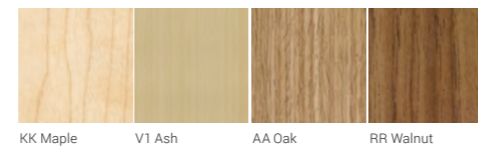

Plexiglas®

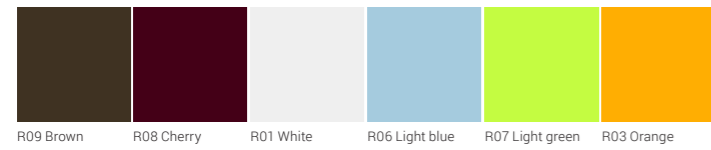

PET felt

100% Polyester fiber (>50% post-consumer polyester)

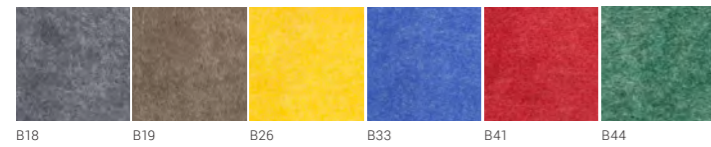

Metal

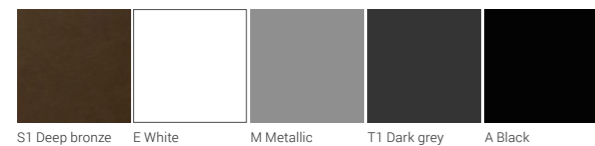

UPHOLSTERY MATERIALS

Synergy

95% Virgin Wool, 5% Polyamide

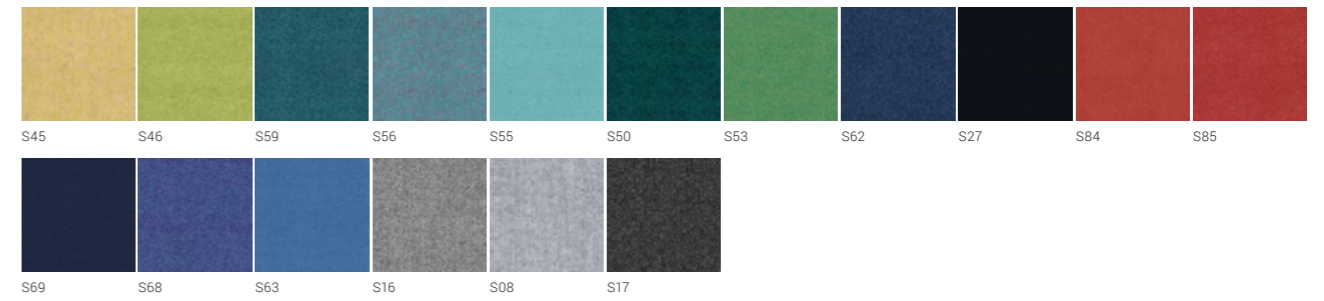

Velito | Velito Presto

88% Wool, 12% Polyamide

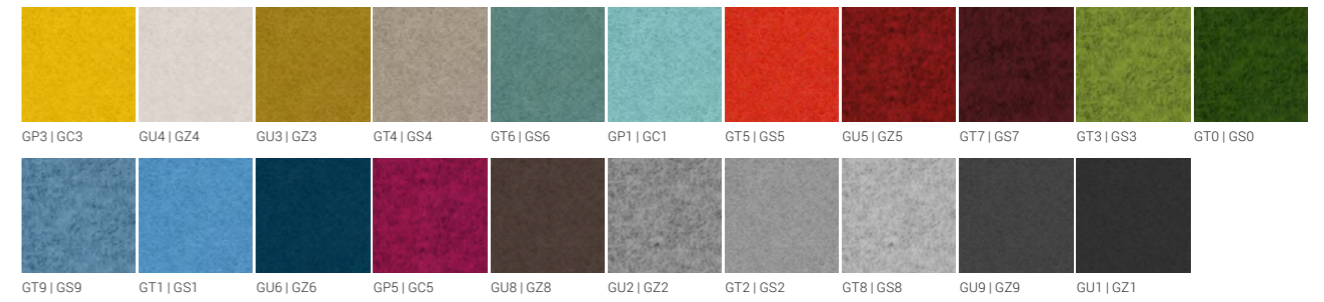

Step | Step Melange

100% Trevira CS® Flame Retardant Polyester

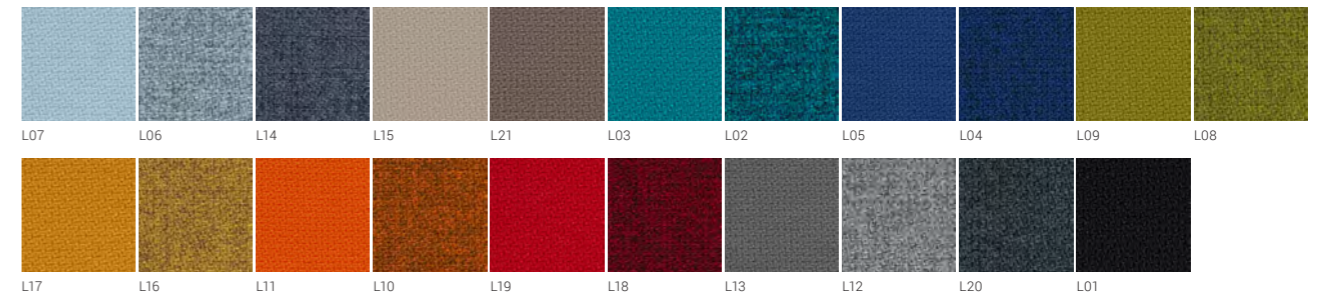

Era

100% Polyester

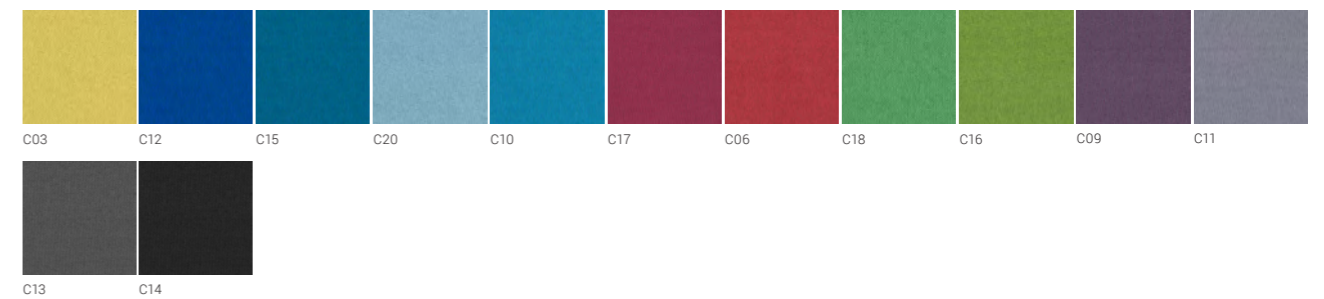

Berta

100% Polyester

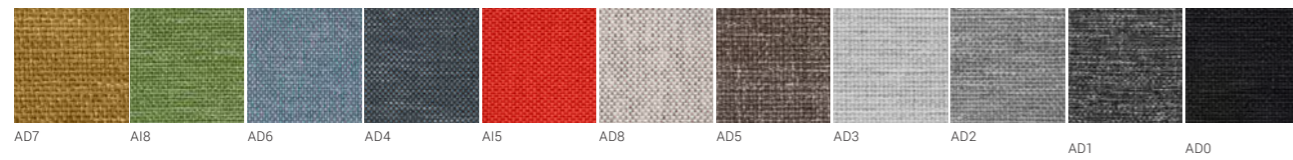

Xtreme Plus

100% Recycled Polyester

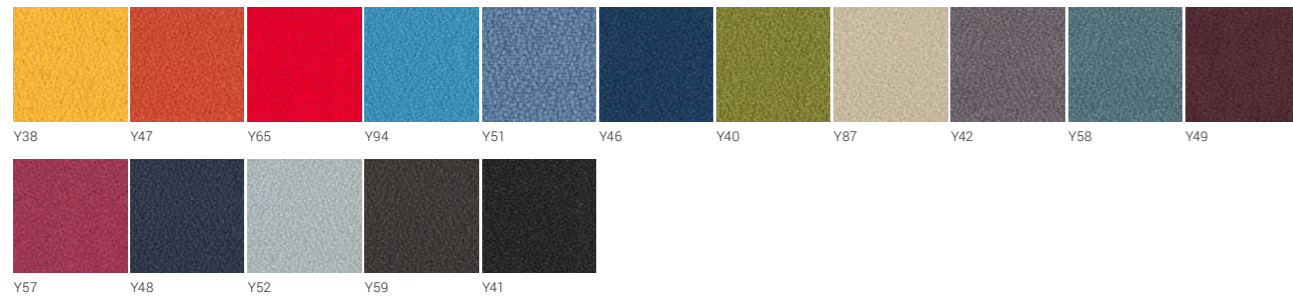

Lucia

100% Recycled Polyester

364

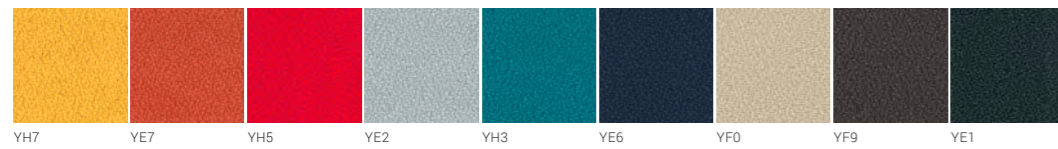

Bondai

100% Polyester

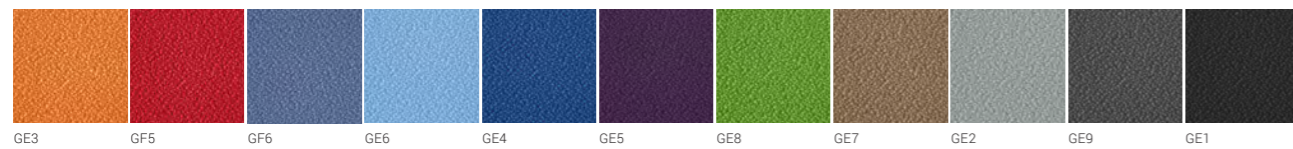

RNN

21% PES, 31,5% COT, 47,5% PU



DNN 

Real leather



Runner mesh

100% Polyester (20% Recycled Polyester)

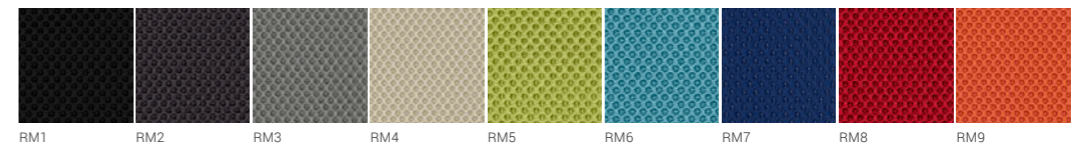

Knitted mesh

100% Polyester

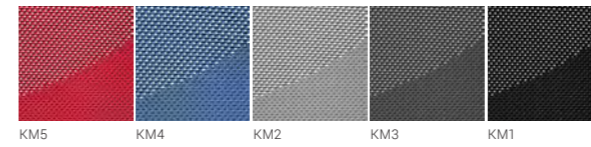

Micro

100% Polyester



PM

70% PVC, 30% PES

365

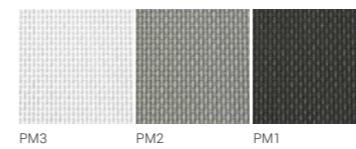

GM

100% Polyester

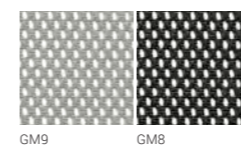

Definition of icons



TILT MECHANISM

The backrest and seat base are linked. When user leans back the whole chair tilts.



KNEE TILT MECHANISM

The backrest and seat base are linked. When user lean back the whole chair tilts. This mechanism allows user to tilt back while the feet remain on the floor, no pressure on the back of the shin.

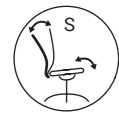

SYNCHRONOUS MECHANISM

The seat tilting angle is smaller than the tilting angle of the backrest, so that the chair would be more comfortable. This mechanism allows user to tilt back while the feet remains on the floor, no pressure on the back of the leg.



WEIGHT-SENSITIVE MECHANISM

Mechanism automatically adapts to the user's weight and movement when leaning back.



TENSION ADJUSTMENT

This adjustment allows user to control the rate and ease with which the chair reclines for different weights and strengths.



LOCKING POSITIONS

The backrest of the chair has multiple locking positions with different angles for comfortable working, reading or resting.



BACKREST TRAVEL LIMITATION

The backrest travel is limited to 3 positions with back locking in the upright work position.

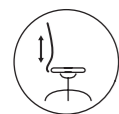

BACKREST HEIGHT ADJUSTMENT

The backrest height can be individually adjusted according to the height of the user.



SLIDE SEAT

This adjustment helps the user to regulate the distance between the backrest and front edge of then seat, thus providing optimum support for the upper thighs. Correctly adjusted seat depth helps user to maintain proper back support, while distributing the weight evenly across the seat cushion.

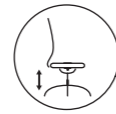

PNEUMATIC HEIGHT REGULATION

This adjustment allows the user to change the height of the seat. Pneumatic mechanism uses pressurized air to lift or lower the seat.

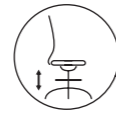

HEIGHT ADJUSTABLE FOOTRING

The footring of the chair can be adjusted in height for the comfortable position of user's feet and legs without depending on the chair height position. It helps to maintain a correct seating position and avoid unpleasant back and neck pain.

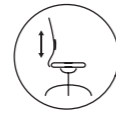

ADJUSTABLE LUMBAR SUPPORT

The lumbar support can be adjusted in height and depth (depending on the chosen chair type). Adjustable lumbar support can be adapted to user's individual curve of the spine. It helps to reduce the muscle strain and protect from the back pain.



LUMBAR SUPPORT

The lumbar support is mounted into the backrest and helps to reduce the muscle strain.



HEADREST

This additional part of the task chair helps to reduce tension in your neck muscles, provides support and comfort to the head and neck while in a reclined position.

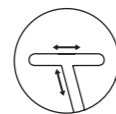

ADJUSTABLE ARMRESTS

Depending on the chair type armrests are adjustable in two, three or four directions (2D, 3D, 4D): height, width, the pad moves forwards and backwards or is rotatable. Height adjustment takes the strain off the neck muscles. Width adjustment and rotation allows the user to position the armrest in proper distance from the body and helps finding the most comfortable support angle.



WRITING TABLET

Rotatable. It allows users to put their notebooks, laptops or tablets upon.



STACKABLE

Chairs can be easily stacked one onto another. Therefore, they are perfect for offices with low storage space.



CONNECTORS

Allow linking chairs in orderly rows.

narbutas

Connect with us:

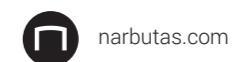

narbutas.com



[linkedin.com/company/narbutas-international](https://www.linkedin.com/company/narbutas-international)



[facebook.com/NarbutasGroup](https://www.facebook.com/NarbutasGroup)



[instagram.com/narbutas_international](https://www.instagram.com/narbutas_international)



[pinterest.com/NARBUTASoffice](https://www.pinterest.com/NARBUTASoffice)

narbutas



EN