

construct

Low Stool and Barstool

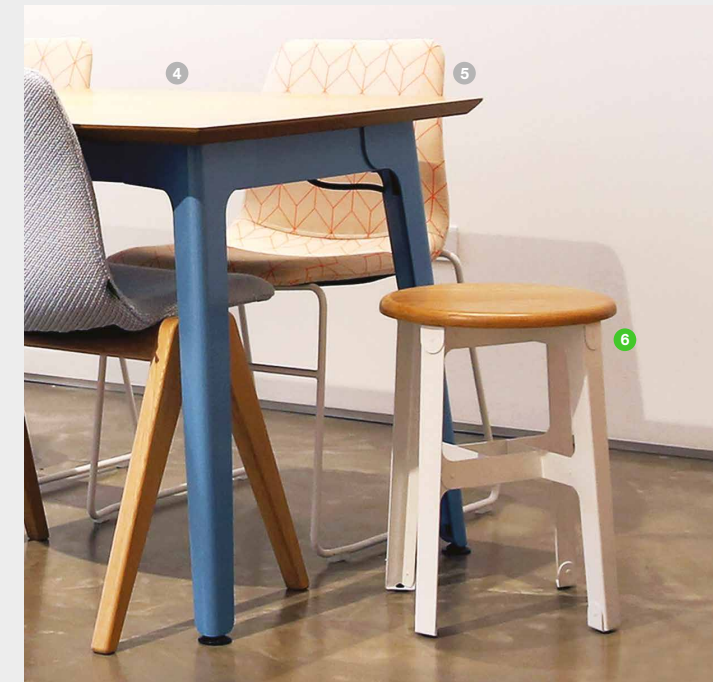

About Construct

The Construct range has an industrial aesthetic thanks to its folded steel frame and visible rivet construction. Paired with a simple solid wood top this stool really wears its construction method on its sleeve.

Compliance

- SCS Indoor Advantage™ Gold Certificate
- FSC®certified products available upon request
- naughtone is FISP and ISO14001 certified
- Our stools are designed to meet or exceed all EN performance requirements per BS EN 16139:2013

Sizes

All dimensions quoted are rounded to the nearest 5mm or nearest 1/2 inch

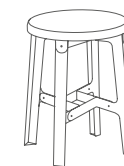

CONLO
Construct Low Stool
mm
W 385 D 385 H 450
inch
W 15 D 15 H 17.5

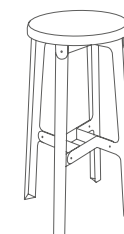

CONCHS
Construct Counter Height Stool
mm
W 425 D 425 H 660
inch
W 16.5 D 16.5 H 26

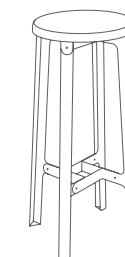

CONBS
Construct Barstool
mm
W 425 D 425 H 760
inch
W 16.5 D 16.5 H 29.5

Top Options



Solid Oak Seat

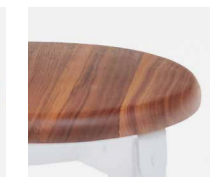

Solid Walnut Seat

Base Finishes



White Powder Coated Standard



Black Powder Coated Standard



RAL Powder Coated naughtone Colours







Construct Stool Technical Specifications

Testing

Our seating is designed to meet or exceed all EN performance requirements per **EN16139:2013**, which includes the following tests:

- Seat and back static load test
- Seat front edge static load test
- Vertical static load on back
- Foot rest and leg rest static load test
- Arm sideways static load test
- Arm downwards static load test
- Vertical upwards static load on arm rests
- Seat and back durability test
- Seat front edge durability test
- Leg forward static load test
- Leg sideways static load test
- Seat impact test
- Back impact test
- Arm impact test

Structural Testing Certifications

CONLO
Construct Low Stool
BS EN 16139:2013, Level 2
Static load 200kg

Servicing



If a component is damaged and needs replacing then please email our team with an image of the damaged part and reference your order number, we will be happy to facilitate any replacements.

Warranty



naughtone offers a **7 Year** warranty across all products. Details on the terms and conditions of naughtones warranty can be found at naughtone.com/warranty

Construct Stool Technical Specifications



Product Code and Description <small>All dimensions quoted are rounded to the nearest 5mm or nearest 1/2 inch</small>	A Width	B Depth	C Height	D Seat	G Weight
1 CONLO Construct Low Stool	385 mm 15 in	385 mm 15 in	450 mm 17.5 in	450 mm 17.5 in	7.7 kg 17 lbs
2 CONBS Construct Barstool	425 mm 16.5 in	425 mm 16.5 in	760 mm 29.5 in	760 mm 29.5 in	9.4 kg 20.7 lbs
3 CONCHS Construct Counter Height Stool	425 mm 16.5 in	425 mm 16.5 in	660 mm 26 in	660 mm 26 in	8.9 kg 19.6 lbs

Dimensions Guide

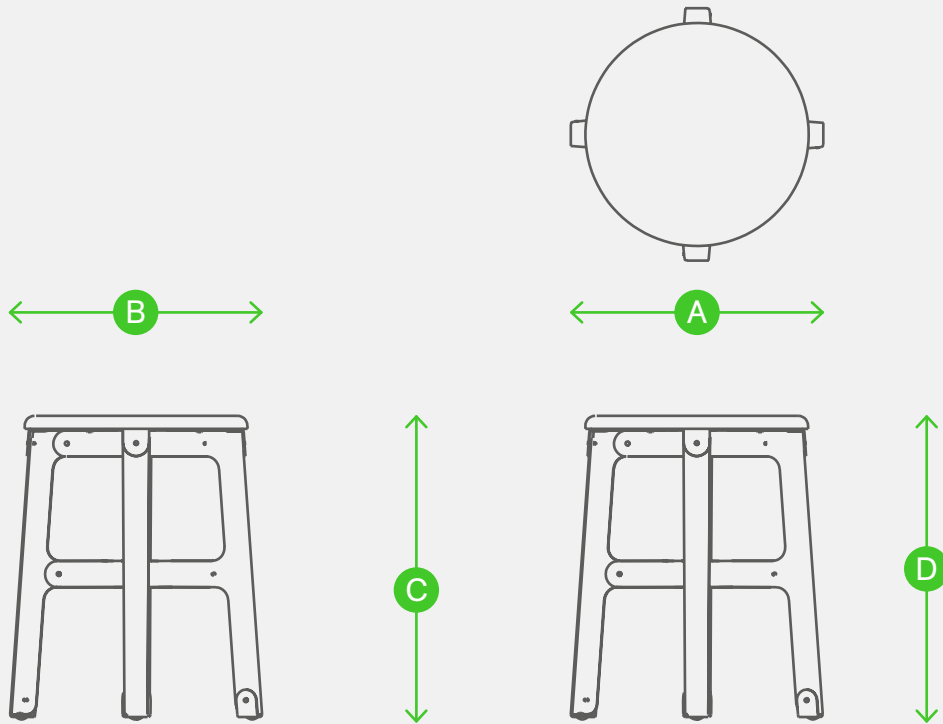

Construct Stool Environmental Product Summary



Environment Attributes

- naughtone is **FISP** and **ISO14001** certified
- naughtone is **FSC®** certified
- **7.7kg** total weight
- **75.5% Recyclable** (frame and fixings)
- **24.5% Reusable** (top and feet)
- **46% Recycled Content** (frame and fixings)
- **Indoor Advantage™ Gold** ANSI/BIFMA Furniture Emissions Standard (M7.1/X7.1-2011 R2016) and ANSI/BIFMA e-3-2014e (Credits 7.6.1, 7.6.2, 7.6.3)

These attributes can help you to achieve criteria towards **LEED, BREEAM, Ska** and **WELL** building certifications



Construct Stool Environmental Product Summary

Material Percentage Split

- 75.25% Mild Steel
- 24.50% Solid Oak
- 0.21% Stainless Steel
- 0.02% Aluminium
- 0.01% Rubber
- 0.00% Powder Coat

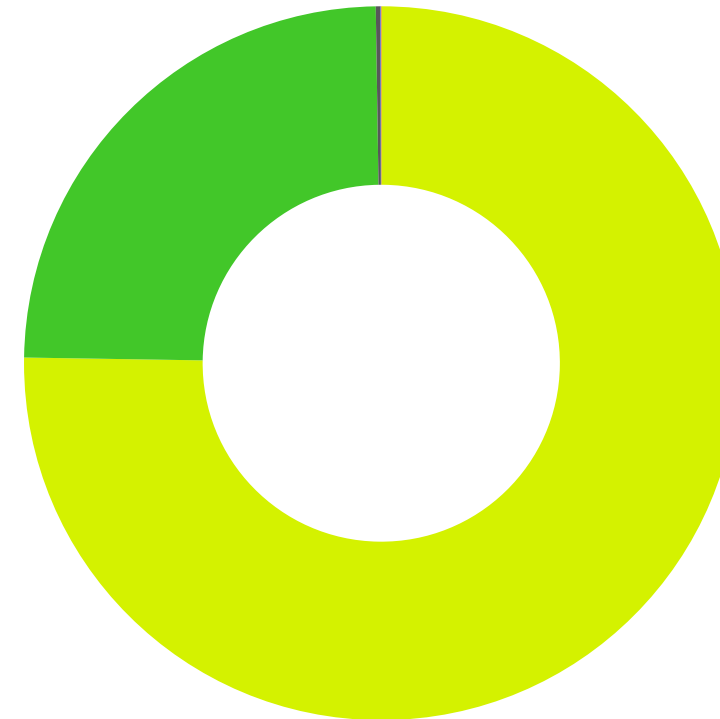

Post Consumer Recycled Content

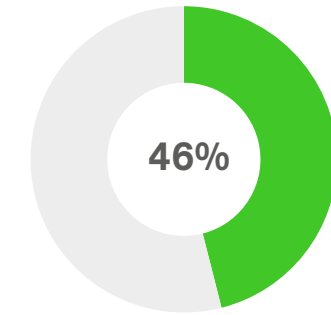

Recyclable Content

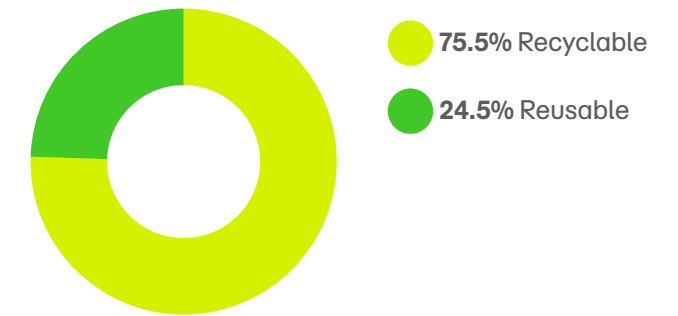

CSR Statement

naughtone has always considered the environment throughout our design and manufacturing process. We understand that as we continue to grow, so does our potential impact on our surroundings. As most of our raw materials are simple, we have great control over their sources, and are proud to be able to offer **FSC®certified** upholstered products and use recycled metals in our table ranges. The addition of our North American manufacturing provision also helps to keep manufacturing miles to a minimum, as our market continues to grow in the USA. Finally, naughtone offers a 'bring back' programme, where the client is able to return the product to our factory, where we will be happy to breakdown and recycle the parts for you.

Product Specific Design Statement

The Construct range is available in a variety of different heights and finishes but for the purpose of this document we have a specific example from the range:

Construct Low Stool with a solid oak top

The Construct low stool is made from laser cut, folded mild steel and held together by aluminium aircraft rivets then finished with a polyester powder coat.

The components are further attached with discreet welds.

The solid oak top is pieced together with individual planks, before being sanded smooth and CNC cut to the required size. It is then finished with a hard wearing spray matt lacquer.

The top and frame are assembled together by hand using minimal fixings and can be easily disassembled if necessary.





1 Design

Every aspect of the naughtone product ranges has been designed with the environment considered, from ethical material choice and production efficacy to storage efficiency and ease of disassembly.

Dense foam sets and resilient fabrics are selected for their longevity and effectiveness across sectors. Durable high quality finishes such as powder coated bases in a range of colours allow clients the freedom of finish options. Finish samples are available allowing clients to make informed decisions and retain to add to their finish libraries for future reference.

2 Raw Material

Local supply of raw materials is employed for the production of our products when possible, procured from suppliers that are quality inspected for extraction methods and meet the highest environmental standards.

3 Production

As many of our products are assembled by hand the energy expenditure wasted from machinery during the production process is kept to a minimum.

All fabrics are cut to ensure optimum efficiency with fabric usage and reduced waste consumption per unit.

All production sites have recycling facilities for any excess product that cannot be used elsewhere, which is then managed by a professional third party.

4 Distribution

Distribution of naughtone products generally occurs directly between the manufacturing site to the client. Production is localised when possible to the US or UK regions, reducing the carbon footprint and miles travelled for each product.

Many items are flat packed for delivery or shipped disassembled with efficient, minimised packaging; optimizing the transportation vessel space.

5 Usage

naughtone products do not require energy or water to function, thus no environmental exchange takes place and no waste is generated during the life of the product.

The only foreseeable need is the cleaning of the product for general maintenance. This includes regular vacuuming to remove dirt and dust particles on upholstery items, and using a dry or damp cloth to wipe non-upholstery items.

This is recommended for all products utilised under conditions of normal wear and is expected to have negligible environmental impacts.

6 End of Life

Although our products are durable and demonstrate timeless design, naughtone products are manufactured in such a way that they can be easily disassembled at the end of life and most of the componentry can be either recycled or re-used as applicable.

As a company we are also happy to accept the return of products, to help re-home or recycle furniture or components at the end of the products useful life.

UK Showroom

6 Bakers Yard
Clerkenwell
London EC1R3DD
T: +44 (0)20 389 22 788

US Showroom

Suite 11-88
222 Merchandise Mart Plaza
Floor 11
Chicago IL 60654

naughtone HQ

Knaresborough Tech Park
Manse Lane
Knaresborough HG5 8LF

T: +44 (0) 1423 816 500
E: sales@naughtone.com

www.naughtone.com